



vLoc3-9800 User Handbook (English Edition)

Version 1.7

P/N: 4.04.000107



General Safety & Care Information

Who Can Use This Equipment

- This equipment must only be used by people suitably trained in the use of pipe and cable locators.

Work-site Safety

- Use your company's or other applicable safety codes and rules when using this equipment.
- Unless having the required authorization, license, and appropriate training, do not connect any pipe, cable, or conductor.
- The equipment should not come in contact with corrosive or hazardous chemicals or gases, or dust.
- **Do not** directly connect this equipment to cables or pipes that have a potential difference to ground of greater than 25V AC.

Equipment Safety

- **Do not** open the enclosures (housings) of either the transmitter or receiver.
- Place the ground stake firmly in the ground before connecting the cable from the transmitter.
- **Do not** hold any uninsulated portion of the connection leads & clips when the transmitter is switched on.

Batteries and Environmental Safety

Vivax-Metrotech products use four types of batteries:

- Alkaline batteries
- Ni-MH (Nickel-Metal Hydride) batteries – rechargeable
- Lithium-Ion batteries – rechargeable
- Lithium-Metal batteries – (small non-rechargeable button cells for "clock" applications)

1. Alkaline Batteries (Non-Rechargeable)

- When replacing the alkaline batteries – use only the size and type specified – **do not** mix battery types (rechargeable and alkaline).
- **Do not** mix partially discharged and fully charged cells in the same battery pack – **do not** mix old with new.
- **Never** attempt to charge alkaline batteries.

2. Nickel-Metal Hydride Batteries (Rechargeable)

- When using rechargeable batteries, use only the correct charging device supplied or specified by the manufacturer. The battery pack or the battery charger will contain circuitry to manage the charging process – other chargers (even if they have the same connector, polarity, voltage & current rating will not have the same control circuitry and can cause damage to the product, overheating, and in extreme cases fire or harm to the individual.
- **Do not** assume that if the plug fits, it is the correct charger – a charger with the correct part number **must** be used – just because it is a Vivax-Metrotech charger and the plug fits **do not** mean it is the correct charger.
- Before using for the first time, charge rechargeable batteries for six hours. If the rechargeable batteries **do not** last as long as anticipated – discharge fully and charge for six hours.
- Care should be taken when charging batteries – **Never** repeatedly recharge batteries (or turn the power off & on) without using the instrument. If used with an inverter in a vehicle – charge the product, then unplug the charger and **do not** charge again until the rechargeable batteries have been used for at least ten minutes. Failure to do this could result in the overcharging of the battery, which will shorten the battery's life and could, in some circumstances, cause overheating or fire.
- If the product becomes hot during the charging process, **immediately** unplug the charger and use the rechargeable batteries for ten minutes before recharging. If this reoccurs the next time the unit is charged – return immediately to Vivax-Metrotech for repair.
- **Do not** charge batteries for prolonged periods without using the locator for at least ten minutes. Charging for a prolonged period could overcharge the battery, reduce battery life and, in extreme circumstances, cause damage to the locator and fire in extreme circumstances.

3. Lithium-Ion Batteries (Rechargeable)

- Lithium-Ion Batteries – some products use Lithium-Ion batteries – the requirements for marking and transportation are still developing. Please contact Vivax-Metrotech before shipping products containing Lithium-Ion batteries or Lithium-Ion battery packs on their own for any "special instructions."

4. Lithium-Metal Batteries (Non-Rechargeable)

- Commonly known as "button cells," these are small – non-rechargeable batteries used to power internal "clocks" within some units (similar to computers). Generally, they have a life of three to five years.
- Under no circumstances should any attempt be made to charge these batteries.
- Dispose of your company's work practice/environmental standards, the prevailing laws, or recognized best practices. Always dispose of batteries responsibly.

5. General Rules regarding Disposal of Batteries

- **Never** disassemble a battery or battery pack.
- **Never** dispose of in a fire or water.
- Dispose of batteries following your company's work practice/environmental standards, the prevailing laws, or recognized best practices. Always dispose of batteries responsibly.

6. Transportation of Lithium-Ion and Lithium-Metal Batteries

- The Lithium-Ion and Lithium-Metal batteries used in Vivax-Metrotech products meet the required safety standards and include the designated protection circuitry.
- Recent regulation changes require that when batteries with Lithium-Ion and Lithium-Metal batteries are transported, the packaging must include specified warning labels.
- **Please contact Vivax-Metrotech Customer Service (USA 1-800-446-3392, International +1-408-734-1400 (USA Pacific Time Zone)) for more details.**
- Regulations have also changed regarding the shipping of spare battery packs (battery packs that are not inside a product). There are limitations on the weight of the package, and the packaging must be marked with the appropriate warning labels.
- **Please contact Vivax-Metrotech Customer Service (USA 1-800-446-3392, International +1-408-734-1400 (USA Pacific Time Zone)) for more details.**
- Vivax-Metrotech vLoc Series 3 products using Lithium-Ion batteries are classified as "not restricted." They can be shipped normally by road/rail/sea & air (passenger & freight aircraft) without restrictions.



IMPORTANT

Remember – Batteries contain dangerous chemicals – They can be affected by many things such as water ingress or heat – In some circumstances, they can explode. They also can cause electric shocks!

Care of Equipment

- Use equipment only as directed in this User Handbook.
- **Do not** immerse any part of this equipment in the water.
- Store in a dry place.
- Keep equipment in the case provided when not in use.
- If left for a prolonged period – remove alkaline batteries.
- Keep the unit clean and free of dust and dirt.
- Protect against excessive heat.

Care when Interpreting the Information provided by the Locator

- This instrument locates and provides depth and current readings based on electromagnetic signals radiating from the buried cable or pipe. In most cases, these signals will enable the locator to pinpoint both position depth and current correctly.
- **Beware** – in some cases, other factors will distort electromagnetic fields radiating from the cable or pipe being located, resulting in incorrect information.
- Always locate responsibly and use information learned during your training to interpret the information provided by the locator.
- **Do not** provide information regarding the depth of cable or pipe to anyone unless authorized by your company.
- **Remember** that depth measurements are to the center of the electromagnetic field or pipe – In the case of pipes, this may be significantly deeper than the top.

American & Canadian Safety Notices

USA

- This transmitter and receiver comply with the general conditions of operation, pursuant to part 15 of the FCC Rules.
 - CFR 47 Part 2
 - CFR 47 Part 15
- Changes or modifications not expressly approved by the manufacturer could void the user's authority to operate the products.



CANADA



- Equipment is for use by trained operators only and not for general household or consumer use.
- Operation is subject to the following two conditions: (1) this device may not cause interference, and (2) this device must accept any interference that may cause undesired operation of the device.

EUROPE

- Vivax-Metrotech confirms that the location system is compliant with the relevant provision of European directive 1999/5/EC.
 - EN 55011
 - EN 61000-4-2: A1 & A2
 - EN 61000-4-3
 - EN 61000-4-8: A1
 - ETSI EN 300 330-2
 - ETSI EN 301 489-1
 - ETSI EN 301 489-3

Table of Content

1. Service & Support	1
1.1 Serial Number and Software Revision Number	1
1.2 Worldwide Sales Offices and Service Centers	2
2. vLoc3-9800 Receiver	3
2.1 vLoc3-9800 Receiver Overview	3
2.2 Charging the Receiver Batteries	4
2.3 vLoc3-9800 Receiver Keypad	5
2.4 Setup Menu	5
2.5 Self-Test	7
2.6 Warnings and Alerts	7
2.6.1 Warning and Alerts Descriptions	7
2.7 vLoc3-9800 Locate Modes and Screens	7
2.7.1 The vLoc3-9800 Status Bar	8
2.7.2 Active Locate - Auto Left/Right Mode	8
2.7.3 Manual Left/Right Mode (Active modes only i.e. not available in Power or Radio modes)	9
2.7.4 Manual Peak Display Mode	9
2.8 Information Pushbutton - Depth & Current	10
2.9 Passive and Active Location	11
2.9.1 Passive Locating	11
2.9.2 Active Locating	11
2.9.3 DFT (Discrete Fourier Transform)	11
2.10 Active Locating: Applying the Transmitter's Signal	13
2.10.1 Direct Connection	13
2.10.2 Transmitter Signal Clamp (for frequencies above 8kHz)	14
2.10.3 Induction (for frequencies above 8kHz)	15
2.11 Locating Active Signals	16
2.12 Searching (sweeping) an Area in the Peak Mode	17
2.13 Searching (sweeping) an Area in the Omni Peak Mode	17
2.14 Tracing a Buried Line	18
2.15 Pinpointing & Confirming the Buried Line	18
2.16 Depth & Current Measurement	18
2.17 Distorted Fields	19
2.18 Sonde Location Mode - Locating Non-metallic Pipes or Ducts	19
3. Data Logging	22
3.1 Bluetooth  Bluetooth	23
3.1.1 Fitting the Bluetooth Module	24
3.2 Pairing with external GPS or Dataloggers	24
3.3 Transferring Data from the vLoc3 receiver to a Computer	25
3.3.1 MyLocator3	25
3.3.2 MyLocator3's Basic Operation	25
3.3.2.1 Updates Page	25
3.3.2.2 Application Update	26
3.3.2.3 Locator Firmware update	26
3.3.3 Toolbar	27
3.3.4 Data Logging 	27
3.3.5 Splash Screen 	28

3.3.6	Frequencies Page 	30
3.3.7	Menu Settings 	30
3.3.8	Advanced Features	31
3.3.8.1	Supervisor Lockouts	31
4.	Loc3 Series Transmitters	32
4.1	Loc3 Series Transmitter Overview	32
4.1.1	The Transmitter Display	32
4.1.2	Pushbuttons	33
4.1.3	Transmitter Information Pushbutton	33
4.1.4	Connections Block	33
4.2	Transmitter Batteries - Li-ion and Alkaline	34
4.3	Charging the Transmitter Battery Tray	34
4.4	Removing and Installing the Battery Tray	35
4.5	Transmitting Modes	35
4.5.1	Direct Connection Mode	36
4.5.2	Clamp Mode	36
4.5.3	Induction Mode – 5 and 10-Watt Transmitters Only	37
4.6	Transmitter Frequencies	37
4.6.1	Frequencies and Maximum Power Output	37
4.6.2	Most Used Frequencies (Frequency Selection) Feature	38
4.6.3	Multi-Frequency Mode for Direct Connection	39
4.7	Transmitter Link (TX-Link) 	40
5.	Accessories & Options	43
5.1	Transmitter Signal Clamps	43
5.2	A-frame Fault Locator	43
5.3	vLoc3-MLA (Marker Locator Adapter)	43
6.	Glossary	44

1. Service & Support

1.1 Serial Number and Software Revision Number

When requesting product support, always quote your receiver and transmitter model number, serial number, and software revision number. They can be found as follows:



1. Model & Serial Number



NOTE

Software Revision Number: The software revision number is displayed momentarily on the LCD during the startup sequence on the receiver and transmitter. It can also be viewed by going to the "About" section of the user menu.

1.2 Worldwide Sales Offices and Service Centers

Worldwide Sales Offices and Service Centers	
<p>World Headquarters, United States of America Vivax-Metrotech Corporation 3251 Olcott Street, Santa Clara, CA 95054, USA T/Free: 1-800-446-3392 Tel: +1-408-734-3880 Fax: +1-408-734-1415 Website: www.vivax-metrotech.com Email: SalesUSA@vxmt.com</p>	<p>Central/South America and the Caribbean Ventas para América Latina 3251 Olcott Street, Santa Clara, CA 95054, USA T/Free: 1-800-446-3392 Tel: +1-408-734-3880 Fax: +1-408-743-5597 Website: www.vivax-metrotech.com Email: LatinSales@vxmt.com</p>
<p>Canada Vivax Canada Inc. 41 Courtland Ave Unit 8, Vaughan, ON L4K 3T3, Canada Tel: +1-289-846-3010 Fax: +1-905-752-0214 Website: www.vivax-metrotech.ca Email: SalesCA@vxmt.com</p>	<p>France Vivax-Metrotech SAS Technoparc - 1 allée du Moulin Berger, 69130 Ecully, France Tel: +33(0)4 72 53 03 03 Fax: +33(0)4 72 53 03 13 Website: www.vivax-metrotech.fr Email: SalesFR@vxmt.com</p>
<p>Germany Metrotech Vertriebs GmbH Am steinernen Kreuz 10a, 96110 Schesslitz, Germany Tel: +49 9542 77227-43 Website: www.vivax-metrotech.de Email: SalesEU@vxmt.com</p>	<p>United Kingdom Vivax-Metrotech Ltd. Unit 1, B/C Polden Business Centre, Bristol Road, Bridgwater, Somerset, TA6 4WA, UK Tel: +44(0)1793 822679 Website: www.vivax-metrotech.co.uk Email: SalesUK@vxmt.com</p>
<p>China Vivax-Metrotech (Shanghai) Ltd. Building 10, Lane 1158 Zhongxin Rd., Songjiang District, Shanghai, China, 201615 Tel: +86-21-5109-9980 Website: www.vivax-metrotech.com Email: SalesCN@vxmt.com.cn</p>	

2. vLoc3-9800 Receiver

2.1 vLoc3-9800 Receiver Overview

The vLoc3-9800 is a precision location system designed to meet the needs of utility companies and their contractors.

In this manual, the vLoc3-9800 Receiver may be referred to as a vLoc3 series, a vLoc3 receiver, receiver, or locator.

The following describes the features and use of the receiver:



- | | |
|----|--|
| 1. | vLoc3-9800 receiver |
| 2. | Battery charger with power cord
*one of supplied based on geographical location |
| 3. | Li-ion battery |
| 4. | Alkaline battery holder |
| 5. | Mini-USB cable |
| 6. | User manual |
| 7. | Padded kit carry bag |



- | | | | |
|----|---|----|--|
| 1. | Pushbutton Keypad and Display | 5. | Mini-USB port data transfer and firmware updates |
| 2. | Model# & Serial# | 6. | Battery compartment cover |
| 3. | Battery retaining cover | 7. | Accessory socket and charging point |
| 4. | AA Battery Pack/Rechargeable Battery Pack | 8. | Expansion sockets for additional features such as the Bluetooth module |

2.2 Charging the Receiver Batteries

The vLoc3-9800 can be used with either alkaline batteries or an interchangeable rechargeable battery pack.



The central illuminated section within the battery icon indicates the amount of charge remaining.

- Green center indicates rechargeable batteries
- Blue center indicates Alkaline batteries
- When batteries are low the remaining charge section becomes red and will flash

Just before shutdown the following symbol will be shown:



Rechargeable batteries are supplied with a mains charger. This is specific to the batteries. Avoid using other manufacturers' chargers as these may damage the battery pack and overheat the battery pack.

To charge the rechargeable batteries, first make sure the pack is inserted in the receiver battery compartment as charging is done inside the receiver.



Connect the charger to the charging socket of the receiver. Connect the charger to the mains and switch it on. The LED indicator on the charger will illuminate red until the batteries are fully charged, at which time the LED will change to green.



WARNING

Rechargeable batteries are supplied with a mains or 12V DC charger. These are specific to the batteries. Only use the charger that is appropriate for the batteries in the product. Failure to use the appropriate charger could damage the battery pack, locator and, in extreme cases cause a fire. If in doubt, call our customer service department at +1(800) 446-3392.

Avoid charging the unit in extreme temperature conditions. (i.e., below 0°C and above 45°C)

Although Vivax-Metrotech batteries include all the required safety-related features, always immediately discontinue using the charger and battery pack if the battery pack becomes excessively warm. Return both to where they were purchased for investigation.

Always ensure batteries have at least a partial charge if stored for long periods without use.

Dispose of all batteries following your company's procedures and or Federal/State and local regulations.

Never dismantle batteries, put them in a fire, or get wet.

2.3 vLoc3-9800 Receiver Keypad

The grey color keys (3, 5, and 6) serve dual functions. You may have to **short press** by momentarily pressing the key or **long-press** by pressing and holding the key until the desired function is shown.

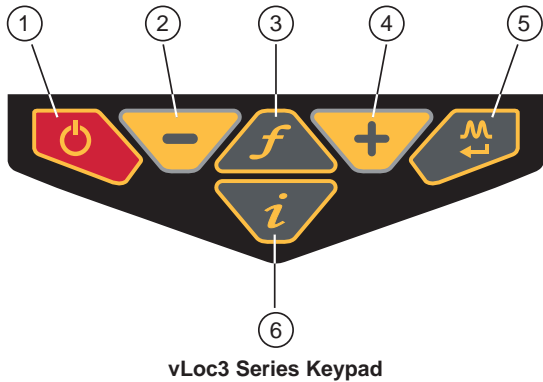

- | | |
|----|---|
| 1. | On/Off |
| 2. | Reduce sensitivity. (Also scroll up when in menu) |
| 3. | Select frequency
Long press = show the pre-selected frequency table |
| 4. | Increase sensitivity. (Also scroll down when in menu) |
| 5. | Enter Key
Short press = change antenna response when in classic screen
Long press = change the locate perspective |
| 6. | Information and Depth key
Short press = enter the information and logging screen
Long press = enter the menu |

2.4 Setup Menu

The vLoc3-9800 has several features that can be turned on and off. These features are accessed through the user menu.

Switch on the unit by pressing and holding the On/Off key until the start-up screen appears. The start-up screen can be configured to the user's preference and is described later in the manual. Otherwise the start-up screen will default to the one below:



Access to the User Menu is via the "i" button. Press and hold down the button until the menu appears.

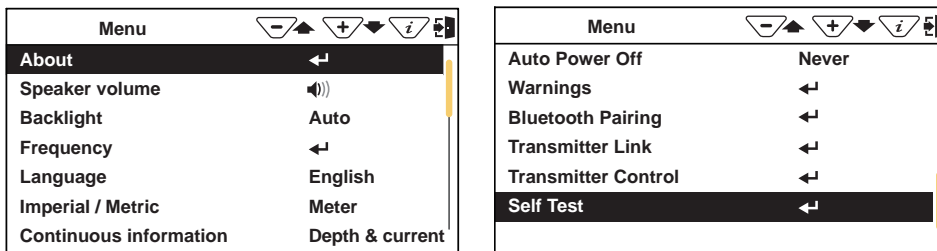

Main Menu

Note that the manual shows two screens, but only one is shown on the vLoc3 display at a time.

Note that where you see this sign , it means that pressing the enter button gives access to the sub-menu associated with this button.

To exit the menu or sub-menu, press the "i" button.

Where the icon is not shown, the enter button is used to scroll through that feature's options.

The features are described below:

About - This section holds the data about the locator such as software revision, calibration data etc.

Speaker Volume - Press the enter button to scroll through the speaker volume settings.

Backlight - Press the enter button to change the backlight intensity setting. Note that a high backlight setting will affect battery life.

Frequency - Use the enter key to enter the Frequency sub-menu. Scroll up and down the table using the "+" and "-" keys. The table contains all available frequency options. To simplify the operation of the unit, select only the frequencies applicable in your application. To do this use the enter key to check the boxes on the right. Frequencies not checked will not appear on the locate screen.

Frequency	
1.45kHz	<input type="checkbox"/>
2.0kHz	<input type="checkbox"/>
8.01kHz	<input type="checkbox"/>
8.19kHz	<input checked="" type="checkbox"/>
8KFF	<input checked="" type="checkbox"/> A
8.44kHz	<input type="checkbox"/>
9.5kHz	<input type="checkbox"/>
9.8kHz	<input type="checkbox"/>

Note also that certain frequency options have an A-frame icon next to them. This indicates that these frequencies are selected to be used with the fault find A-frame.

Language - The unit may be supplied with different language options. Use the enter key to select the language of choice.

Imp/Metric - Select either Imperial or Metric measurements.

Marker Locate - Use the enter key to enter the Marker Locate sub-menu. Scroll up and down the table using the "+" and "-" keys. The table contains all the available marker type options. To simplify the operation of the unit, select only the marker types applicable in your application. To do this use the enter key to check the boxes on the right. Marker types not checked will not appear when using the vLoc3-MLA to locate markers.

Continuous Info - The Locate Screen can display a continuous reading of either Depth, Current, Both, or None.

Auto Power Off - The unit can be set to switch off after a set time. Options are 5-minutes, 10-minutes, or Never. Note that when the A-frame is connected, the timer is set to "Never."

Warnings - Warnings relating to Swinging or Overload can be configured. Scroll down to the relevant warning and use the return button to select or deselect.

Bluetooth Pairing (optional feature) - Press the enter button to enter the Bluetooth pairing routine. This allows the unit to link with external devices such as data loggers and GPS devices with Bluetooth capability.

Satellite Info - This menu option is available only if a Bluetooth module is installed in the receiver. Enter the sub-menu to see all the data relating to Satellite reception/data etc.

Transmitter Link - Enter the submenu to gain information relating to the transmitter link status. For more information, refer to section 4 relating to the Loc3 series transmitters.

DFT (Discrete Fourier Transform) - DFT is a tool to assist in choosing a frequency to apply to the target conductor. The DFT feature will aid the user with nearby interference that may affect the locate quality.

Regulatory Labels - Shows the FCC ID and IC ID wireless device compliance information.

2.5 Self-Test

The vLoc3-9800 has a self-test feature. The test confirms that the equipment is fit for use, and calibration has not drifted from its expected settings.

To undertake the test, first find an area free from excessive interference such as overhead fluorescent lighting, large transformers etc. Also check that any nearby vLoc transmitters are switched off.

Select "Self-Test" from the user menu and press the "Return" button. The test will self-start. Keep the equipment stationary while the test is completed. After a short while the unit will report a Passed or Failed. Examples are below:



If the unit fails the test, try again in a more interference-free area. If it continues to fail, return the unit to Vivax-Metrotech or one of its approved repair centers for investigation and repair.

2.6 Warnings and Alerts

Warning symbols are accompanied by an audible sound and vibration in the handle unless configured otherwise in the MyLocator3 desktop app. Warnings can also be switched off in the setup menu.

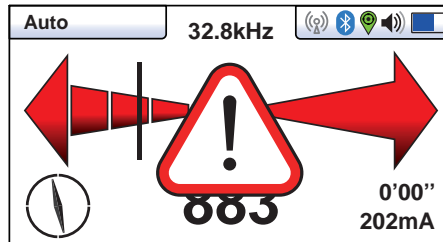

2.6.1 Warning and Alerts Descriptions

ALERT	Alert Description
	Signal Overload - is usually caused by operating close to power transformers or being close to a transmitter in Induction mode. Moving away from the interfering signal will solve the problem.
	Swing Alert - indicates that the operator is swinging the locator excessively, resulting in misleading information. When sweeping the locator across the direction of the line, try to keep it vertical; this will improve its accuracy.

2.7 vLoc3-9800 Locate Modes and Screens

Note - vLoc3 series user interface is under continual development. The screenshots described here may differ slightly from your screens.

The vLoc3 series receivers give the user a choice of locating screens.

The choice of the screen depends on the application and user preference. These screens are:

- Auto Left/Right Mode
- Auto Left/Right Mode
- Sonde Mode
- Manual Peak Mode

2.7.1 The vLoc3-9800 Status Bar

Along the **top right** of the displays are the “Status” indicators which will appear at all times. The **top left** section of the status bar changes depending on which locate mode is being used. The information in the top left section is discussed below in the active and power modes section.

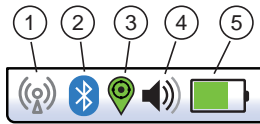

1. Transmitter Link connection status (if installed, see section 4.7)
2. Bluetooth status (If Transmitter link is fitted, this icon  will replace the blue tooth icon as they are mutually exclusive)
3. GPS status (see below for further explanation)
4. Speaker volume setting
5. Battery type and remaining charge

2.7.2 Active Locate - Auto Left/Right Mode

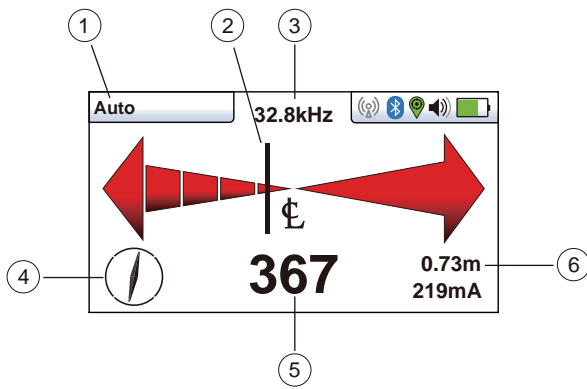

1. Auto/Manual Indicator
2. Moving Pointer
3. Frequency
4. Compass Line direction indicator
5. Signal Strength
6. Depth and Signal current indicator

This screen is not available in the Power or Radio passive modes.

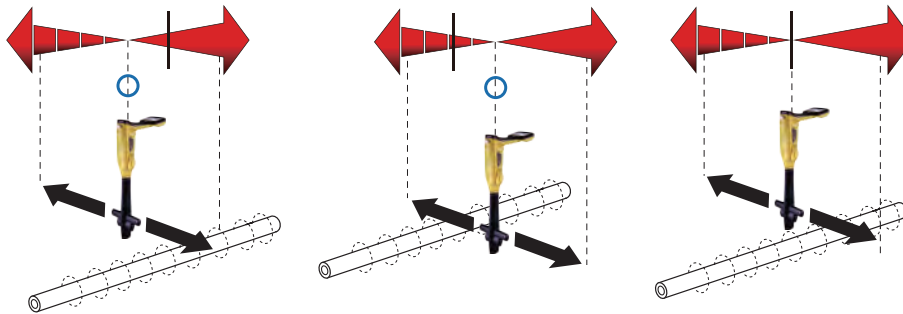

The Left/Right Auto mode is ideal when tracing long-distance lines in less congested sites. It requires no user input to the keyboard allowing the operator to concentrate more on the safety of the surroundings.

A locate signal needs to be applied to the line and is described later in the manual.

As the locator is moved from left to right across the cable the moving bar will move accordingly. When the moving bar is exactly in the middle, the locator is directly over the target line. Try to keep the compass line indicator pointing “North/South” meaning the locator is orientated exactly along the line. At this point the numeric signal level will be at its highest.



NOTE

The speaker emits a pulsing tone while on one side of the line and is solid on the other. This allows the operator to easily judge the position of the line by the tone of the speaker. This allows the operator to locate a line without having to watch the receiver display when walking along busy streets etc.

2.7.3 Manual Left/Right Mode (Active modes only i.e. not available in Power or Radio modes)

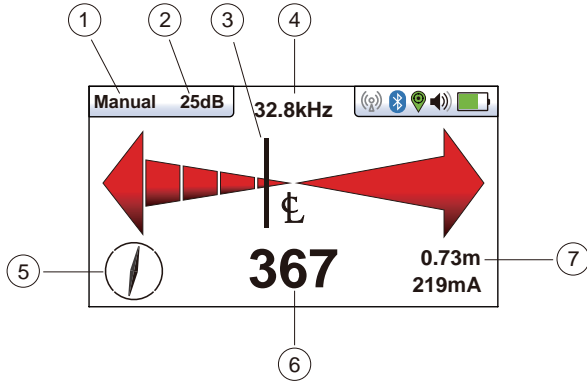

- 1. Auto/Manual Indicator
- 2. Sensitivity Setting
- 3. Moving Pointer
- 4. Frequency
- 5. Compass Line direction indicator
- 6. Signal Strength
- 7. Depth and Signal current indicator

This screen is not available in the Power or Radio passive modes.

The sensitivity is set in the Manual Left/Right mode by pressing the “+” and “-” pushbuttons. The gain setting can be seen in the top left of the screen. This has the advantage of enabling the operator to adjust the sensitivity to signals from a deep pipe or cable. It can also be used to mask out the signal from an unwanted source.

To reject an unwanted signal, first set the sensitivity to a high value such that the unwanted signal is detectable. Sweep across the unwanted signal, reducing the sensitivity until the locate bar ceases to respond to the signal. Now double-check that the wanted line is detectable. Keep the sensitivity at this setting and continue to locate the line.

This display is not available in the Power or Radio passive modes. Use Peak Display for passive modes.

2.7.4 Manual Peak Display Mode

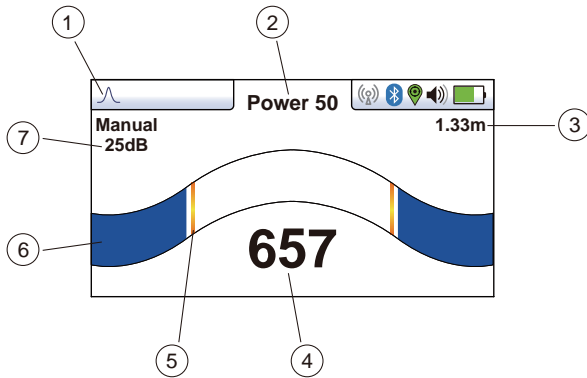

- 1. Antenna mode (In this screen, this will always be “peak” mode)
- 2. Frequency selected indicator
- 3. Depth indicator
- 4. Numeric signal strength
- 5. Peak signal strength indicator
- 6. Signal strength indicator
- 7. Sensitivity setting

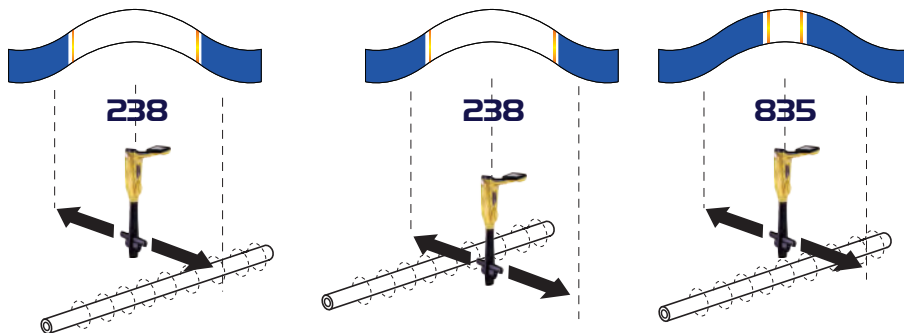

The Manual Peak Display mode is particularly useful in congested areas where multiple signals are radiating from various lines. The sensitivity is set manually by pressing the "+" and "-" pushbuttons. As the locator is traversed across the target line the "curtains" of the bar graph will close. If the curtains are fully closed or fully open, one press of the "+" or "-" will bring the curtains back within scale. A numeric signal level is also displayed (999 represents full scale).

Use the red peak signal indicators on the bar graph to help identify the position of the peak signal.

This mode is also the default screen for Power and Radio passive Modes.

When using the manual peak display mode the relative signal levels become apparent, aiding identification of the target line.

The direction of the line can be determined by rotating the locator on its axis. When the signal is strongest, the line is passing exactly forward/backward.

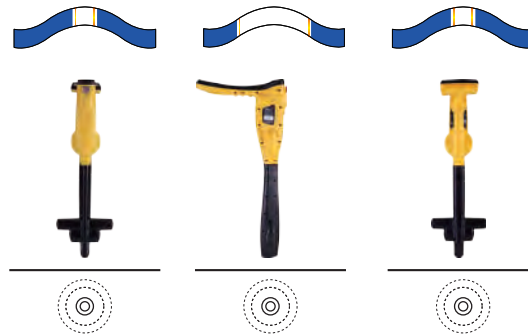

Notice also that if in an active mode and the locator is configured to do so, the depth and signal current are also displayed in the top right of the display. **1.33m**
399mA This information is only correct when directly over and correctly aligned.

2.8 Information Pushbutton - Depth & Current

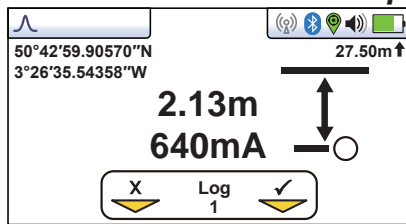

Pressing the "i" pushbutton will display the depth to the center of the radiated signal and the current measurement. Press the pushbutton briefly – remember, if you press and hold, you enter the setup menu. If you enter the setup menu, press the "i" pushbutton again to return to the locating screen then try again.

The accuracy of depth and current readings depends on the quality of the radiated signal being located. If the signal is not distorted, the depth reading will be accurate to within 5% of the actual depth. If the signal is distorted, depth readings will be less accurate.

If measuring the depth of a Sonde, ensure the "Sonde" mode is selected; otherwise the depth measurement will be incorrect. Sonde mode has a different "Info Depth" screen and does not indicate current.

The "Information" screen also indicates Longitude/Latitude and height above sea level coordinates. This is only available if the Bluetooth option is installed, paired with an external GPS, and detects a valid GPS signal.

Datalogging

It is possible to save the data on the info screen to the internal datalog. Pressing the "+" saves the data. Pressing the "-" key rejects the data and returns to the locate screen. The number of logs stored in the device is also indicated.

Datalogging is described in more detail later in the user handbook.



IMPORTANT

When locating a cable or pipe, depth and current measurements should only be taken with the bottom of the receiver standing on the ground directly over and across the target line.

When locating a Sonde depth measurements should only be taken with the bottom of the receiver standing on the ground with the blade in-line with the Sonde.

2.9 Passive and Active Location

2.9.1 Passive Locating

Passive locating of buried utilities rely on electromagnetic signals created by currents that already exist on underground utilities. We group these under two settings:

- Power (P) – these are signals that generally originate from electrical power generation systems. These are around 50/60Hz and their associated harmonics.
- Radio (R) – these are signals that generally originate from low-frequency radio transmissions. These are generally in the range of 16 kHz to 22 kHz.

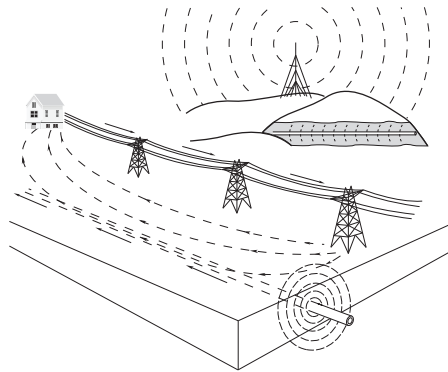

Passive location is used to search an area to see if buried metallic lines are present (known as locating to AVOID). It does not help identify what buried pipe or cable is present, only to confirm a pipe or cable there. For instance, it might be assumed that a signal being detected on the Power mode is radiating from a power cable, but in practice, for instance, this is sometimes from a pipe that has “stray” power currents traveling along it.

A typical application would be to check an area before installing a fence post.



Passive locating can only be done in the Manual Peak Display mode.

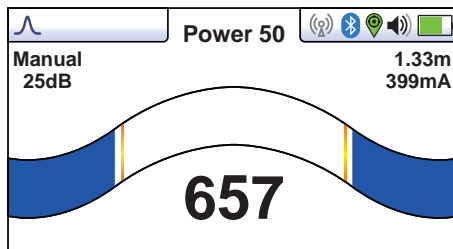

2.9.2 Active Locating

Active locating uses a transmitter to apply a very precise frequency to a pipe or cable. A receiver, tuned to that frequency, is then used to detect that signal. Active locate frequencies can be applied by direct connection, clamp or induction.

This transmitter can transmit a range of active frequencies.

When using a signal clamp, the choice of frequencies is restricted because they are optimized for a specific range of frequencies. The full range of frequencies is only available in the “Direct Connection” mode.

For frequencies below 45 kHz, authorities such as the FCC allow higher power output to be used; for frequencies of 45 kHz and above, power output for this type of equipment is restricted to 1 watt. Therefore more power is available when lower frequencies are used.

2.9.3 DFT (Discrete Fourier Transform)

DFT is a tool to assist in choosing a frequency to apply to the target conductor. The DFT feature will aid the user with nearby interference that may affect the locate quality.



*Note the DFT feature should not solely be used to determine which frequency to apply. ALWAYS follow the appropriate safety requirements mandated by safety legislation, safety practice, or your company’s safety procedures when applying a locate frequency to a conductor.

2 vLoc3-9800 Receiver

1. To perform a DFT assessment, verify any nearby transmitters are powered off to avoid additional signal frequency disturbance.
2. Select your preferred frequencies from the frequency menu. These selected frequencies will be assessed in the next few steps.

Frequency	
128Hz	<input type="checkbox"/>
480Hz	<input type="checkbox"/>
491Hz	<input checked="" type="checkbox"/>
512Hz	<input checked="" type="checkbox"/>
577Hz	<input type="checkbox"/>
815Hz	<input type="checkbox"/>
982Hz	<input type="checkbox"/>
1.02kHz	<input type="checkbox"/>

3. Navigate to the main menu and scroll until you see DFT. Select DFT by pressing the enter key.
4. Once the option is selected, the receiver will automatically assess the user's preselected frequencies.
5. The receiver will scan all available frequencies and display a progress bar and the list of frequencies assessed will be displayed. The frequency under test is shown on the top line.

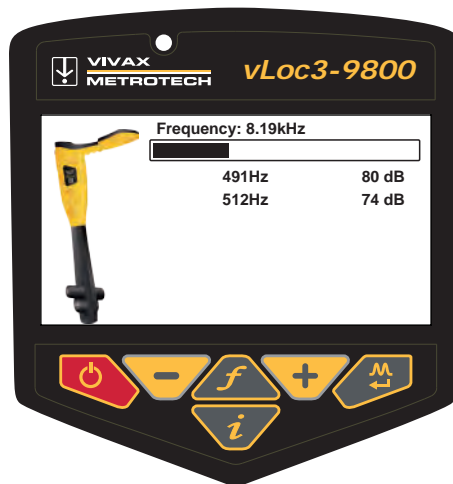

Scan in progress

6. A numerical value ranging from 0dB to 140dB will be shown next to the frequency list, with 140dB the least possible interference detected and 0db with the largest possible interference.
7. The results are ranked from the least interference possible at the top to the largest amount of most possible interference at the bottom.
8. In this case, the higher the dB number (80dB), the less interference has been detected by the receiver.

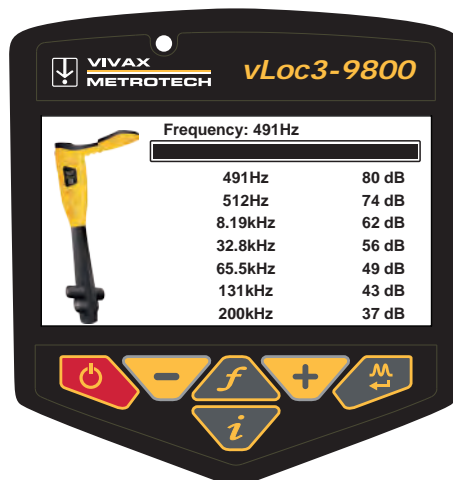



Although frequency results appear to have less interference, it may not be the best choice to locate certain utilities. These include but are not limited to a conductor, current output, resistance, and signal bleed over adjacent utilities.

2.10 Active Locating: Applying the Transmitter's Signal

Active locating uses a transmitter to apply a precise frequency to a pipe or cable then uses a receiver turned to detect the signal being radiated at that precise frequency. Active location frequencies can be applied by direct connection, signal clamp, or induction (further explained in the following sections).

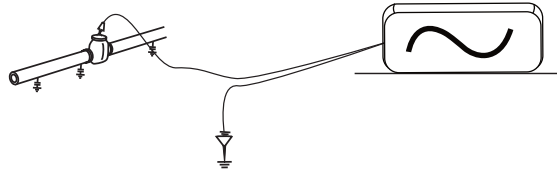

Unlike passive detecting, active locating has the benefit of the operator controlling the signals and can be more specific about what line is detected. Passive signals are also not always present on a line so using active signals ensures more lines are detected.

Choosing the correct frequency depends on the application but as a general rule select low frequencies as these tend to “bleed off” less than higher frequencies. A good general-purpose frequency is 33kHz and is a good starting point if in doubt.

When using Induction or the Signal Clamp, the frequencies available are limited frequencies optimized for the equipment. The full range of frequencies is available in the Direct Connection mode.

For frequencies below 45 kHz, authorities such as the FCC allow higher power output to be used; frequencies of 45 kHz and above power output for this type of equipment are restricted to 1 watt. Therefore more power is available when lower frequencies are used.

To inject a signal requires the use of a transmitter. The transmitter signal can be injected or applied to the target line in a variety of ways.

2.10.1 Direct Connection

This method involves making an electrical connection to the cable or pipe.



WARNING
The direct connection leads are not designed for connection to live cables.



WARNING
Do not touch metal parts of the connection clips when connecting to the line or when the transmitter is on.

To make a direct connection, insert the direct connection connector to the transmitter. Insert the ground stake into the ground a few meters perpendicular to the line. Connect the black lead to the ground stake. Next take the red lead and connect to the target line.

Switch on the transmitter by pressing and holding the On/Off button down for a couple of seconds. Select the desired frequency depending on the application. Check for a good connection by either noting the mA output on the LCD or noting the change in tone rate when disconnecting and then reconnecting the red lead.

Always start with low output and increase the output if the received signal is not strong enough. Setting the output to high when it is not required may result in some signal bleeding off onto other services and will drain more power than necessary from the battery.

It is sometimes impossible to find a suitable projection to apply the connection clip to a ferrous material. If this is the case use a magnet to contact the line and then clip the red clip to the magnet. A good example of this is to make a connection to a street lighting circuit. Usually it is the practice to connect the sheath of a lighting cable to a street lamp's metallic inspection cover. Making a connection to the inspection plate will energize the cable via the plate and sheath. Usually there is no projection on which to clip so using the magnet on the plate provides a suitable clipping point.

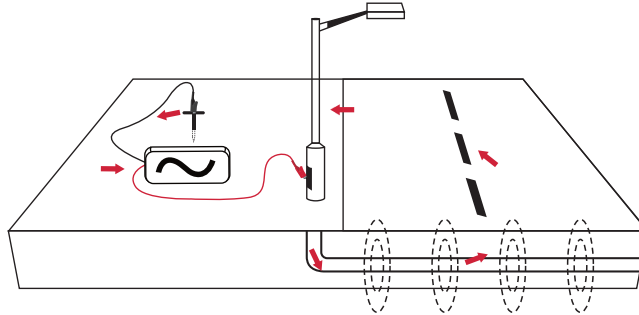

WARNING
Only authorized personnel should make connections to cables.



WARNING
There may be buried lines nearby when pushing the ground stake into the ground. Check using passive location before inserting the ground stake. Stop if additional resistance is felt during insertion.

2.10.2 Transmitter Signal Clamp (for frequencies above 8kHz)

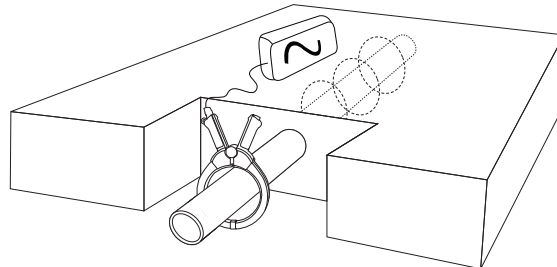

In many situations when it is not possible to make a direct connection to a cable, a signal clamp will provide an efficient and safe method to apply a locate signal.

Note that for best results the cable should be grounded at both ends. The clamp should be fully closed for optimal current induction. A small amount of current will still be induced if the jaws are open.

When clamping around a cable make sure the clamp is placed below the grounding point as shown below.

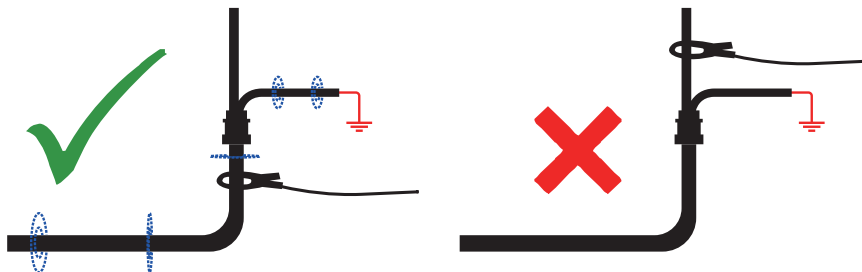

When applying a clamp close to a grounding point where multiple grounds or a grounding bus exists ensure that you place the clamp around the target line and not to the ground bus/other grounds. This will help focus the applied signal on the target line.

Clamp Extension Rod

A useful accessory to the clamp is the extension rod:

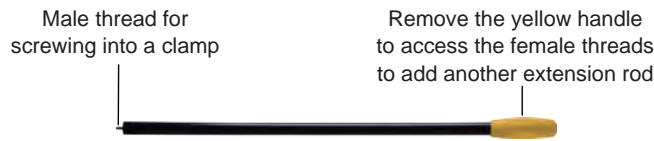

The extension rod is fitted with a 10mm threaded male stud. This male thread screws into the handle of the signal clamp to extend the distance of the clamp. This helps in areas with difficult access such as in manholes or trenches. (not to be used on uninsulated overhead power cables).

The extension rod is fitted with a female thread in the handle. The female thread allows the rods to be joined together to extend the range. To access this thread, slide the yellow handle off the rod.

To operate the clamp jaws when attached to the rod gently pull on the clamp cord to open the jaws. Release the cable to close them.



WARNING

Always follow the appropriate safety requirements mandated by safety legislation, safety practice, and your company's safety procedures when applying a clamp (coupler) to a cable.



BEWARE that when placing a clamp around cables carrying high current the clamp may vibrate, jump or close violently due to induced current from the target cable.

High voltages can be induced back onto the clamp and be present at the clamp's plug-in in some situations. Safety practices should be followed at all times when clamping around live target lines!

Always ensure the clamp is connected to the transmitter before clamping around a line.

2.10.3 Induction (for frequencies above 8kHz)

This is used when the direct connection leads, or clamp cannot be used. If no connection leads or the clamp is connected to the transmitter, the "Induction" mode will automatically select.

An induction loop or coil is fitted inside the transmitter. The transmitter must be placed over the target line in a particular orientation, depending on the type of transmitter used. Check sections 4.5.3 for more information.

Do not place the transmitter on a manhole cover, or any other metallic object, as that object will shield or detune the transmitter, resulting in little or no signal being induced in the target line.

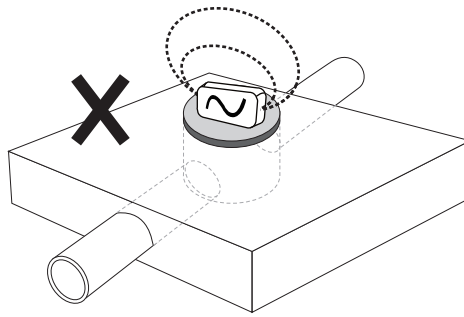

Also note that the signal will radiate out to the side of the transmitter as well as below. For this reason, it is recommended that when applying a signal using the induction method, a distance of at least 20m is kept from the transmitter when pinpointing or taking depth readings. Locating closer than 20m is possible but the operator should be aware that the signal directly received from the transmitter may be strong enough to influence the results.

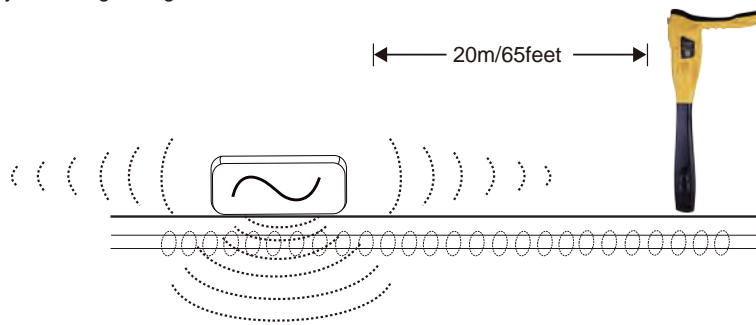

2.11 Locating Active Signals

These instructions assume that the Manual Peak Screen is selected and Peak is selected for the antenna configuration.

1. With a transmitter, apply an active locate signal to the line.
2. Set the receiver to manual peak mode
3. Match the frequency of the receiver to that of the transmitter

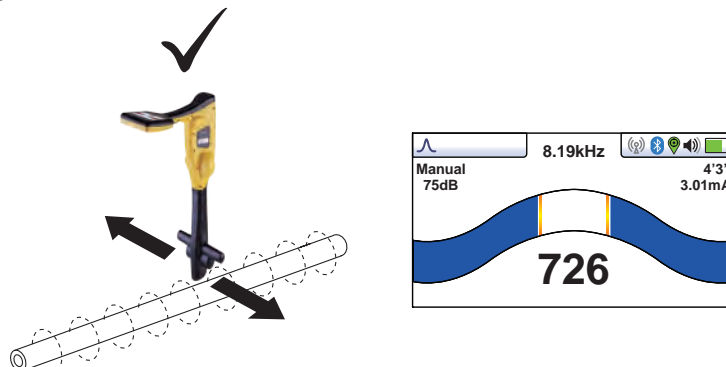

Hold the locator vertically and rotate it on its axis until the compass indicates Forward/Back, as shown above.

Adjust the sensitivity control so that the display indicates approximately 50%. Keeping the vLoc3 receiver vertical move to the side slightly. If the bar graph increases, you are moving toward the line. If it decreases, you are walking away from it. Move toward the line as indicated by the direction arrows until a maximum signal is achieved. It may be necessary to reduce the sensitivity to keep the bar graph on the scale. This is a normal occurrence and should be expected. Try to keep the vLoc3 receiver vertical and avoid swinging it, as this may create false readings.

Move the locator side to side to ensure a maximum signal is detected. Use the peak level indicator to assist.

With the maximum signal found and the compass running Forward/Backward, the vLoc3 receiver is now directly over the line and exactly across it.

If the signal is not distorted, the maximum signal's position will coincide with the position indicated by the arrows. If these two positions do not agree it may be because there is signal distortion. Treat the results with caution.

Continue to trace the line to its destination or source.

If you have selected the Omni Peak antenna configuration arrows will not appear on either side of the compass. This is because when in Omni mode the line can be detected from any direction.



Pressing and holding the “f” key will bring up the frequency table in a locate screen.

Power 50
Power 60
Radio
491Hz
512Hz
8.19kHz
8KFF
9.82kHz
32.8kHz

Use the “+” and “-” keys to navigate quickly to the desired frequency. Press the “f” key to select a highlighted choice and return to the locate screen.

2.12 Searching (sweeping) an Area in the Peak Mode

Buried utilities may be parallel to each other and frequently they cross the area being searched at various angles and depths.

As the locator antennas response is directional (using the traditional screen), it is important to search the area in the same or similar pattern as shown. This orients the antennas in a way that will locate any signals being radiated from the buried utility.

Once a response is found, trace pinpoint and mark the utility. Searching an area in this way is generally but not exclusively done in the Peak mode using passive locating.

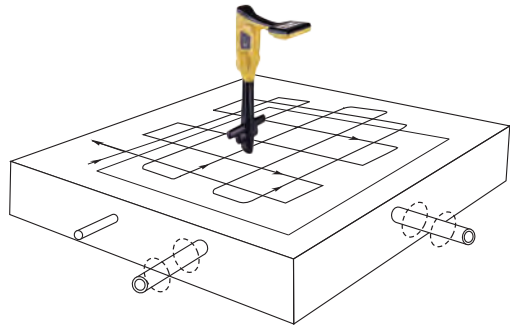

2.13 Searching (sweeping) an Area in the Omni Peak Mode

Searching in the Omni Peak mode is similar to the Peak mode, except it is only necessary to sweep an area in one direction. A zig-zag motion is enough rather than a full grid action because the locator will respond to a signal from a line in any direction. It has the benefit of cutting the sweep time in half.

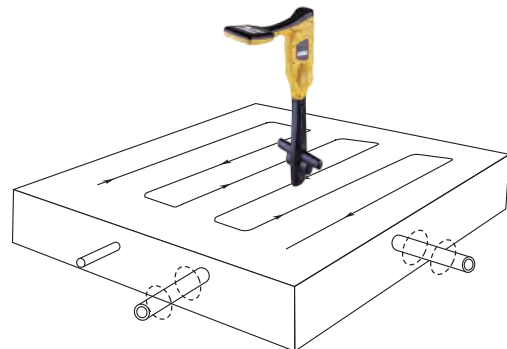

2.14 Tracing a Buried Line

Where possible trace out from the transmitter connection point. Having pinpointed the line, hold the locator vertically and in front of you with the compass line indicator pointing forward/back. Start by moving the locator left to right/right to left over the line. Keep the movement over the center of the line, i.e., the largest meter response, adjusting the gain when necessary. Whenever practical it should be traced to the point that provides additional confirmation of what type of service is being located, i.e., a telephone pedestal, a manhole cover, etc.

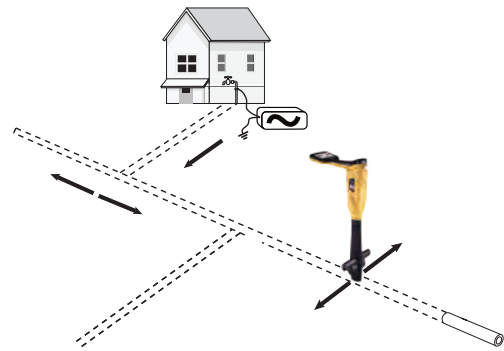

2.15 Pinpointing & Confirming the Buried Line

Marking the exact position of the buried line is generally called pinpointing. Pinpoint the line before marking its position. Place the receiver in “Manual Peak” or “Left/Right” mode, pass the blade of the receiver across the path of the cable and identify the position as indicated by the largest signal or as indicated by the Left/Right indicator. Use the “Compass Line Direction” indicator to confirm the line is exactly forward/back.

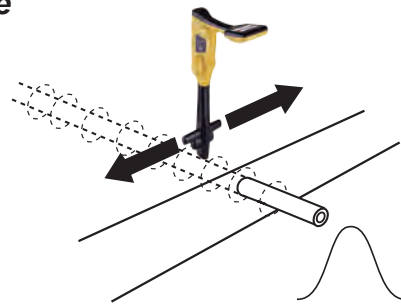

2.16 Depth & Current Measurement

- Pinpoint the cable as described in section 2.10.6, “Pinpointing & Confirming the Buried Line,” with the receiver in line with and directly above the buried line – measure the depth (d) by pressing the “d” pushbutton briefly. Unless configured differently, the current will be displayed at the same time as the depth.
- Be careful when locating in congested areas or close to bends or T’s. They may be inaccurate due to distorted fields.

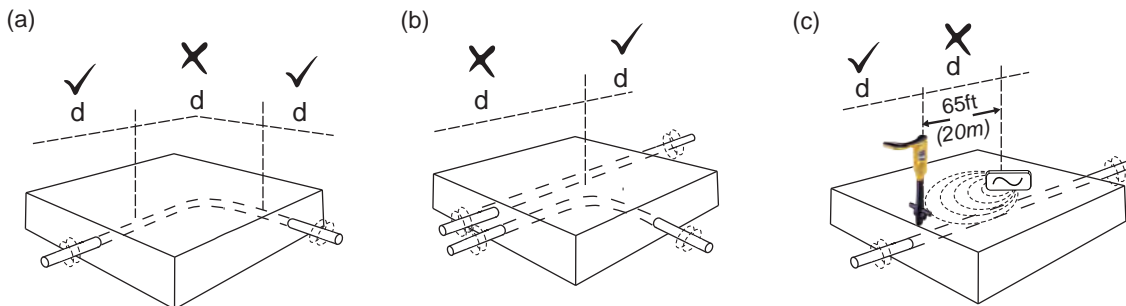

- An alternative method of verifying depth is triangulation which can be done in the “Manual Peak” mode.

- Pinpoint the line as previously described. Adjust the gain so that full-scale deflection is just achieved.
- Move to one side until the meter deflection (using the numeric display may be easier) reads 70% (700).
- Mark that position, then repeat on the other side.

The distance between the two 70% marks will be the same as the depth of the line.

A) Peak Mode (Iwin Antenna)

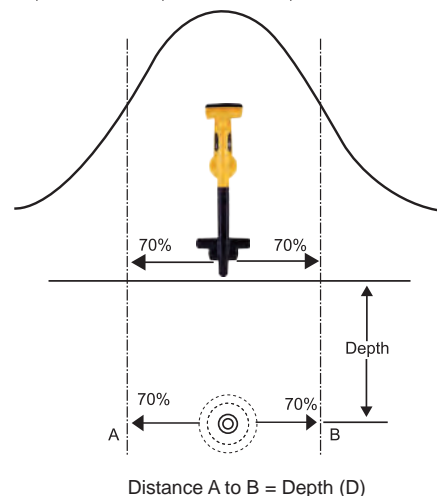

- Measuring the signal current.
 1. Pinpoint the line as for measuring depth.
 2. Briefly press the “i” pushbutton and the depth and current will be displayed.

The further from the transmitter the less signal will radiate from the buried line. By locating at several points along the buried line you will identify an approximate rate of signal loss - beware that where a pipe or cable divides the signal will reduce more rapidly.

If the signal current at the point you are pinpointing is different from the trend, check to confirm that the correct cable is located. To do this, return to a point where the current is as expected and very carefully trace the line to the new location, regularly checking that the current has not changed significantly. A sudden change in current may be caused by straying onto an adjacent line.



WARNING
Never mechanically dig over the path of a buried pipe or cable. Always dig carefully and call before you dig.

2.17 Distorted Fields

The accuracy of measurements is affected by the distortion of the signal being radiating from the target line. Distortion can be caused by stray signal currents leaking onto other lines or when the target line takes a sudden different course. One way to check for a distorted signal is to follow the procedure below:

To check if other radiated fields are distorting the signal. First locate the cable in either mode.

- Place the locator on the ground and take a depth reading by pressing the “i” pushbutton.
- Note the result and then raise the locator approximately 1.5ft (0.5m).
- Take another depth reading and check the depth has increased by approximately this amount.
- If the depth has not increased by the correct amount, treat the results with caution.

2.18 Sonde Location Mode - Locating Non-metallic Pipes or Ducts

A Sonde is typically used for locating non-metallic pipes or ducts or the camera end of a sewer inspection camera. Low-frequency versions (512Hz/640Hz) can transmit through some metallic pipes such as cast iron pipes which is why they are frequently used with sewer inspection cameras.

Sonde Location is a Peak mode which means that the bar graph and audio will grow when approaching the sonde and at their maximum when over the sonde.

Locating Sondes method:

1. Switch on the Sonde by connecting the battery. Connect it to the pushrod and place it at the start of the pipe run.
2. Switch on the vLoc3-9800 and select Sonde mode using long presses on the “Return” button. The Sonde icon will now be visible on the screen.

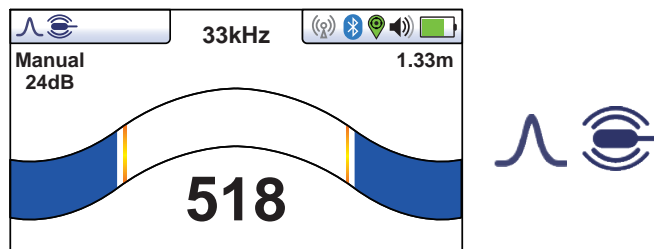

3. Position the vLoc3-9800 above the Sonde as indicated below: (The rotational orientation of the receiver is 90° to that used when line locating).

2 vLoc3-9800 Receiver

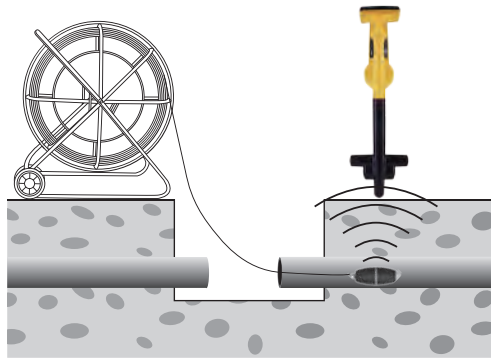

4. Adjust the sensitivity control so that the bar graph reads approximately 75%. Now move the vLoc3-9800 forward and back to detect the largest signal. You will also notice that there will be a “ghost signal” in front and behind the Sonde. This is normal and characteristic of locating Sondes.

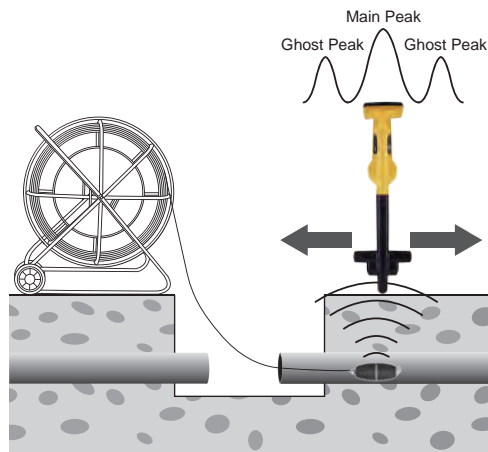

5. Now sweep left and right over the Sonde to obtain a second peak. Note that there are no ghost signals when sweeping left to right over the Sonde.

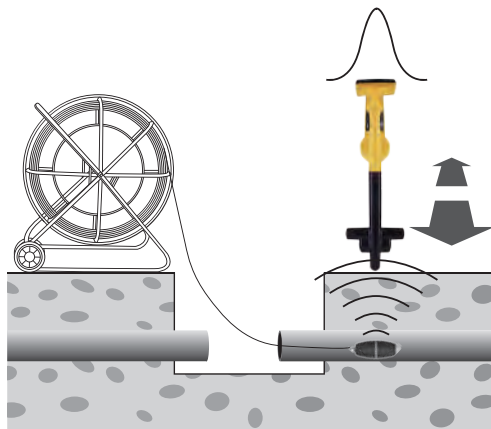

Finally, check that the vLoc3-9800 is in line with the Sonde by rotating its axis to obtain a peak signal. The vLoc3-9800 is now over the Sonde and in line with it.

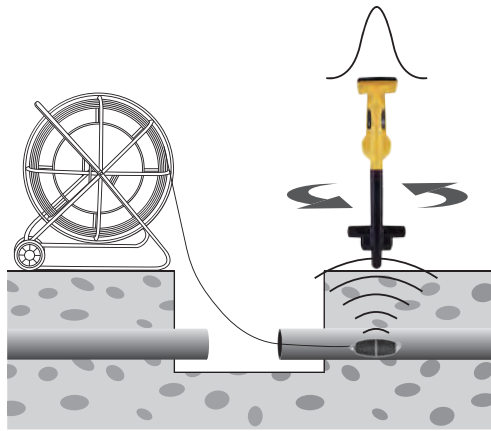

6. If a depth estimation is required, place the vLoc3-9800 on the ground, pinpointing the Sonde above. Momentarily press the “I” button and the depth will be displayed. To exit the depth screen, either wait for the depth screen to “time out” or momentarily press the “I” button, returning the vLoc3-9800 to the locate screen.
7. Now push the Sonde in a couple of meters and repeat the above to mark out the route of the pipe or duct. Keep the insertion intervals small (2 to 3m) to ensure the Sonde is not lost.

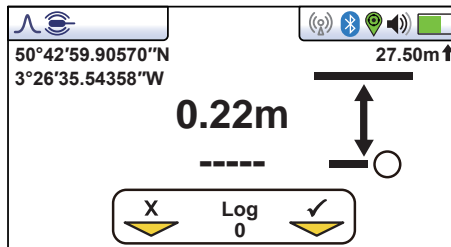

Sonde depth screen

3. Data Logging

The vLoc3 series receivers have internal storage memory that can be used to store locator data. The records are user-initiated and stored whenever the “+” button is pressed in the “Information” screen. Data can be stored relating to a standard locate or receiver accessories apart from the Remote antenna accessory. Each time a self-test routine is run the results are automatically recorded in the equipment. Warnings and Alarms are also automatically recorded.

1. To store a record first locate a point of interest.

Hold the vLoc3 receiver stationary over the target and press the “i” pushbutton.

In the depth and current screen press the “+” pushbutton to save the data.

The Log number indicates the number of records stored. To exit the screen without logging the data press the “-” button.

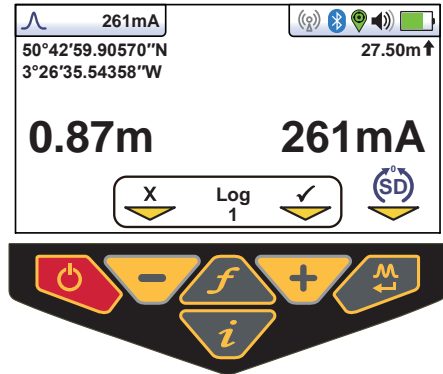

If the GPS function is enabled, the GPS coordinates will also be displayed and attached to any saved file. For more information on Data logging and GPS see section 3.2.

2. When the save button is pressed the Log number will increment and the arrow below the check sign will turn green indicating that the data has been stored successfully.

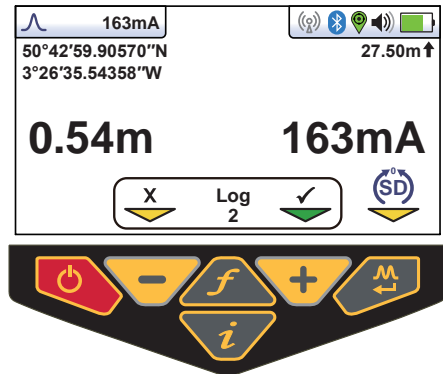

3. The screen will then automatically revert to the locate or accessory screen.

The data logs can also be deleted from the Info screen.

4. From the Info screen, press and hold the “-” key.

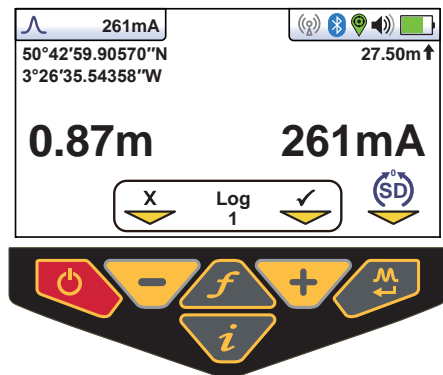

3 Data Logging

5. Press the “+” key to confirm.

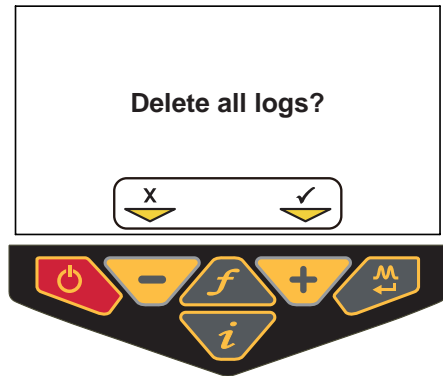

6. Press the “-” key to delete or the “+” key to cancel.

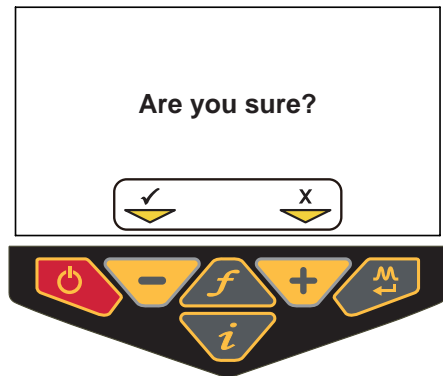

7. After the deletions are complete, the vLoc3 receiver will return to the locate screen.

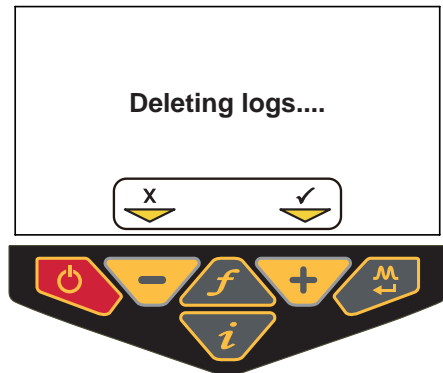

3.1 Bluetooth Bluetooth

As an option, the vLoc3 series receivers can be upgraded by the user with a Bluetooth module to communicate with external GPS modules or Dataloggers.



vLoc3 Series Bluetooth Module

3.1.1 Fitting the Bluetooth Module

1. Turn the receiver off and remove the battery pack.
2. With a small cross-head screwdriver remove the two screws of the module cover and remove the cover.



Remove screws



Remove cover

3. The slot on the left is for the Bluetooth module. The slot on the right is not active and is for future developments. Carefully slide the Bluetooth module into the slot and press to secure it in the slot with your thumb.



Install the Bluetooth module into the left slot

4. Replace the cover and tighten the two retaining screws being careful not to overtighten.
5. Install the receiver battery and switch on the unit. After a few seconds a black Bluetooth icon should appear showing that the module is fitted.
6. If the Bluetooth icon is grey this means the GPS option is not fitted or incorrectly fitted.
7. The Bluetooth module can communicate with external devices that are also Bluetooth enabled. Generally Bluetooth devices fall into two categories of high and low power devices. The vLoc3 Bluetooth module is compatible with low-power devices..

3.2 Pairing with external GPS or Dataloggers

First check that a Bluetooth module is installed in the vLoc3 receiver. A grey color GPS icon on the status bar shows that no Bluetooth module is installed. A Black GPS icon indicates that the Bluetooth module is installed.

Bluetooth pairing with external devices.

1. Switch on the external device.
 2. Switch on the vLoc3 receiver and enter the user setup menu by a long press on the "i" button.
 3. Use the "+" and "-" keys to scroll to and select Bluetooth Pairing.
 4. Press the Enter key.
 5. Press the Enter key to start a Bluetooth search for external devices.
 6. A list of available devices will be shown.
 7. Scroll to the desired external device and press the Enter key.
 8. Double press the "i" button to return to the main screen.
- After a few seconds the Bluetooth icon should turn blue indicating the device has paired successfully.

The unit will remember the pairing even after switching off. However the unit can only remember one unit at a time so if the unit is paired with another device the settings will be replaced.

GPS (Global Positioning System)/GNSS (Global Navigation Satellite System)

The vLoc3 series receivers can utilize location data from an external GPS/GNSS. The vLoc3 receiver needs to be paired with an external device (see the previous section on Bluetooth devices).

Once paired with an external device the vLoc3 receiver will await valid GPS data from the external device. The GPS icon will turn green when a valid GPS signal is detected. Whether the device is doing a "cold" or "hot" start can take a few seconds to a few minutes.

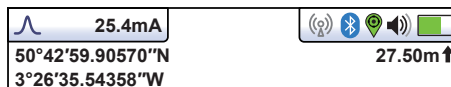

3.3 Transferring Data from the vLoc3 receiver to a Computer



MyLocator3

One method of transferring data is to use the vLoc3 Series Configurator Tool "**MyLocator3**". This free desktop program can be downloaded from the Vivax-Metrotech website.



VMMMap

Another method to access the locator data is by using the **VMMMap App** which will store all the locator's data in the web portal. See our website under "Apps" to learn more.



TIP

To view Google kml files, the Google Earth app is needed.
This free app can be found by doing a google search for Google Earth.

3.3.1 MyLocator3

This section describes the user operation of the MyLocator3 PC application.

MyLocator3 is a desktop PC application capable of downloading code and configuring the vLoc3 series of locators.

The first part of this document, Basic Operation describes usage not requiring a USB security dongle. The second part of this manual, Advanced Features describes usage requiring a security dongle.

MyLocator3 is a free downloadable App available at www.vivax-metrotech.com in the Apps section.

Follow the instructions to download and install the application. A "MyLocator3" icon will appear on the computer desktop after the app is installed.

Connect your vLoc3 series receivers to the computer via the mini-USB connector found under the battery cover flap. Launch MyLocator3 by double-clicking on the icon.

3.3.2 MyLocator3's Basic Operation

MyLocator3 operation does not require a USB security dongle.

3.3.2.1 Updates Page

When a locator is first connected to the PC the Updates Page will be displayed. The updates page will show the locator variant type, serial number, and running firmware in the upper left-hand boxes. The upper right-hand box will show information about the MyLocator3 PC application.

Clicking on the Clock symbol sets the locator time to UTC. To check local and UTC hover over the Icon and the times will be displayed to the right flashing alternately.

Checking the "Auto Load Config" box ensures the locator's configuration setting is automatically uploaded to the MyLocator3 app when the locator is connected.

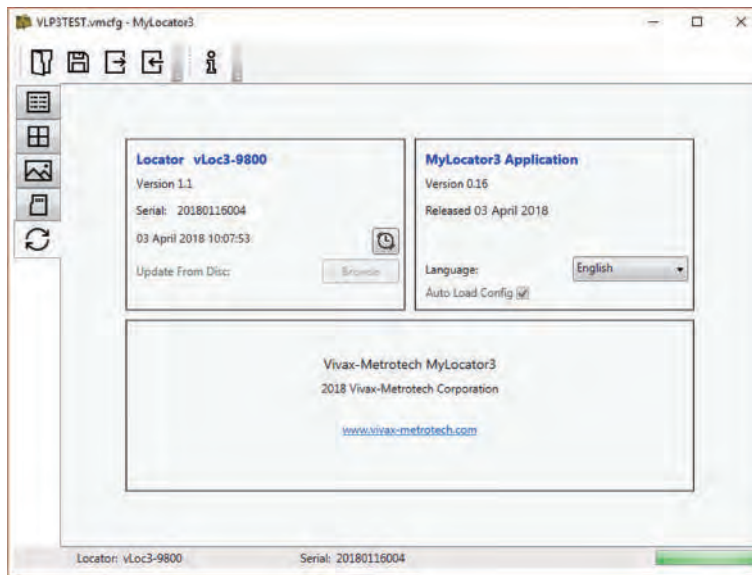

The MyLocator3 Start Page

MyLocator3 can be viewed in several language options. Click on the pull-down menu to select the desired option.

3.3.2.2 Application Update

Every time the MyLocator3 Application is started, its version number is checked against the latest version available on the Vivax-Metrotech server. The user is notified if an update is available as in the below illustration. This feature will only be available if the computer is connected to the internet.

Clicking on the Update Now button will download the latest version from the Vivax-Metrotech server which the user can install.

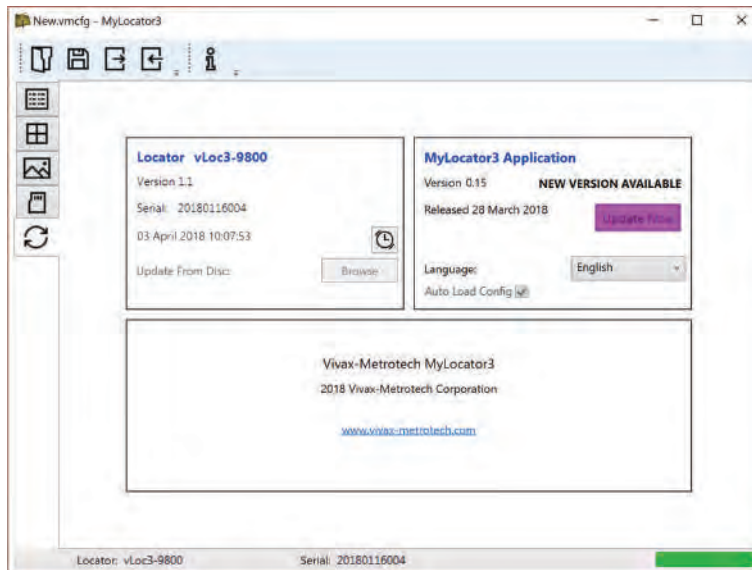

3.3.2.3 Locator Firmware update

Each time a locator is connected to the PC, its firmware version is checked against the latest version available on the Vivax-Metrotech server and the user is notified if an update is available, as shown below. This feature will only be available if the computer is connected to the internet.

Clicking on the Update Now button will fetch the latest version from the server and then download it to the locator.



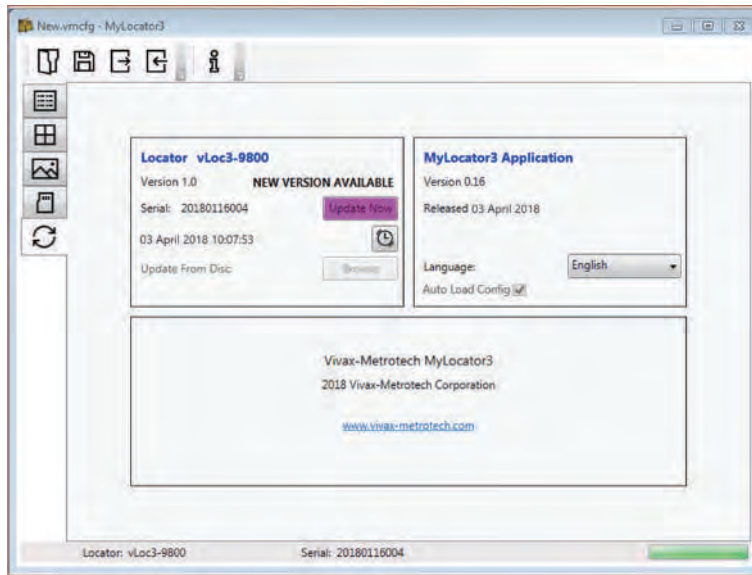

The Update From Disc feature will only be available if a suitable dongle is attached to the PC. This feature allows the user to install older versions of firmware stored on the computer although it is advised that only the latest version of firmware is used.



3.3.3 Toolbar

The vLoc3 series receivers can be configured so that features can be switched on or off. Doing this enables the user to tailor the instrument to meet their application's needs while keeping the user interface uncluttered. The toolbar at the top of the screen enables the user to create configurations.

The application toolbar looks like this:

	<ul style="list-style-type: none">  Opens an existing configuration file (*.vmcfg). <hr/>  Saves the configuration to a file. <hr/>  Writes the configuration to the connected locator. <hr/>  Reads the configuration from the connected locator. <hr/>  Displays information about MyLocator3.
--	--

3.3.4 Data Logging

Clicking on the Data Logging tab will display information about the state of the attached locator's data log contents. The data log contents can be stepped through by using the controls on the right-hand side. The user can upload a selection of logs from the locator to the PC using the upper right-hand side controls. The data in the data log can be configured before exporting. The parameters that can be set are:

- Distance units
- Date format
- Time format, i.e., UTC or local time

Files may be exported and saved locally as .csv, .bin, .kml or .shp files and examined later. The default filename is based on the serial number of the connected locator but can be changed during the saving process.



If it is only required to export a portion of the log (for instance, a survey on a particular day), use the data log scroll facility at the bottom left of the display to scroll through to the start date and time. Note the log number and then scroll to the end date and time and note this log number. Use these numbers to enter the From - To numbers in the display's top right when exporting. Doing so will help to keep the exported data to a manageable size.

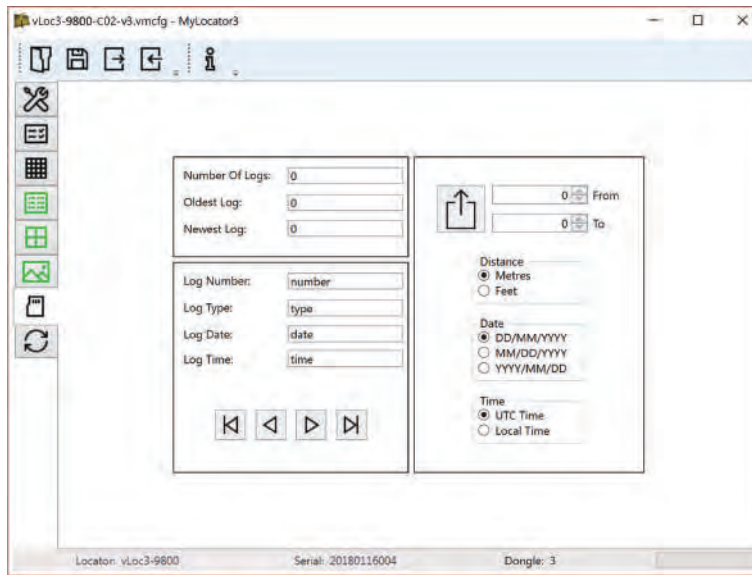

Data Log management screen

Before exporting the data use the Log Type dropdown tab to select the type of data required. Options are:

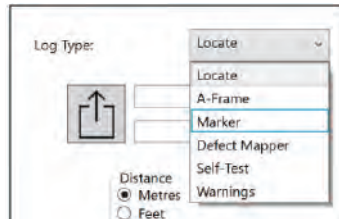

Log type dropdown list

3.3.5 **Splash Screen**

An image can be loaded as a splash screen when the locator is turned on in this section. The locator has an LCD screen with a resolution of 480 by 272 pixels. The image loaded into MyLocator3 will be scaled to fit the width of the screen. If the scaled image height is less than the LCD height, then the image is centered vertically, and white bars are used as padding. If the scaled image height is greater than the LCD height, then the image can be re-positioned vertically by clicking and dragging the left mouse button anywhere on the image.

To insert your startup screen, first, click on the “Open” button. Then browse your files to select the picture required as the startup screen. The application is compatible with file formats .jpg, .bmp, .png and .gif.

The startup screen will be displayed in the application.

The Download button can be used to set the splash screen immediately, or the image can be sent to the locator along with the rest of the configuration by pressing the Write Configuration button.

3 Data Logging

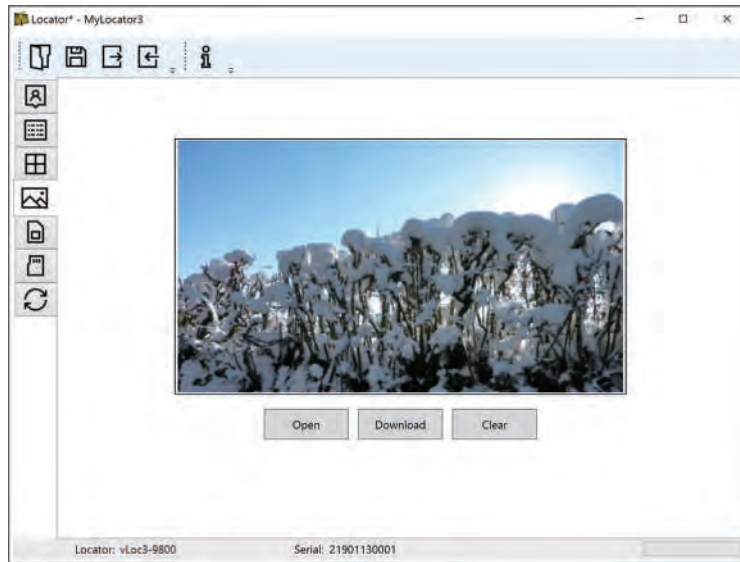

The Splashscreen download area

To remove a startup screen and revert to the default Vivax-Metrotech screen, click on the "Clear" button and download the cleared screen.



The default factory loaded splash Screen

3.3.6 Frequencies Page

The “Frequencies” page allows the user to select which frequencies and modes are available when the locator's F-key is pressed and which frequencies appear on the locator's menu.

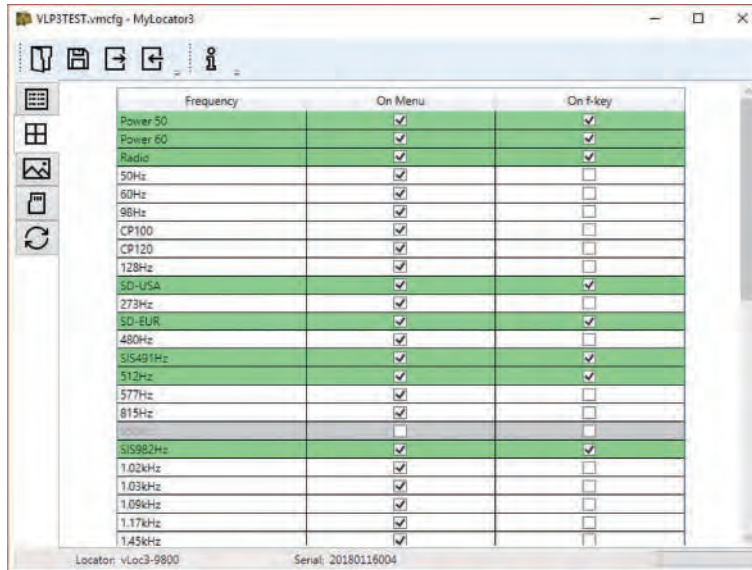

Frequency	On Menu	On F-key
Power 50	<input checked="" type="checkbox"/>	<input checked="" type="checkbox"/>
Power 60	<input checked="" type="checkbox"/>	<input checked="" type="checkbox"/>
Radio	<input checked="" type="checkbox"/>	<input checked="" type="checkbox"/>
50Hz	<input checked="" type="checkbox"/>	<input type="checkbox"/>
60Hz	<input checked="" type="checkbox"/>	<input type="checkbox"/>
96Hz	<input checked="" type="checkbox"/>	<input type="checkbox"/>
CP100	<input checked="" type="checkbox"/>	<input type="checkbox"/>
CP120	<input checked="" type="checkbox"/>	<input type="checkbox"/>
128Hz	<input checked="" type="checkbox"/>	<input type="checkbox"/>
SD-USA	<input checked="" type="checkbox"/>	<input checked="" type="checkbox"/>
273Hz	<input checked="" type="checkbox"/>	<input type="checkbox"/>
SD-EUR	<input checked="" type="checkbox"/>	<input checked="" type="checkbox"/>
480Hz	<input checked="" type="checkbox"/>	<input type="checkbox"/>
SIS491Hz	<input checked="" type="checkbox"/>	<input checked="" type="checkbox"/>
512Hz	<input checked="" type="checkbox"/>	<input checked="" type="checkbox"/>
577Hz	<input checked="" type="checkbox"/>	<input type="checkbox"/>
815Hz	<input checked="" type="checkbox"/>	<input type="checkbox"/>
1024Hz	<input checked="" type="checkbox"/>	<input type="checkbox"/>
SIS962Hz	<input checked="" type="checkbox"/>	<input checked="" type="checkbox"/>
1.02kHz	<input checked="" type="checkbox"/>	<input type="checkbox"/>
1.03kHz	<input checked="" type="checkbox"/>	<input type="checkbox"/>
1.09kHz	<input checked="" type="checkbox"/>	<input type="checkbox"/>
1.17kHz	<input checked="" type="checkbox"/>	<input type="checkbox"/>
1.45kHz	<input checked="" type="checkbox"/>	<input type="checkbox"/>

The Frequency page list

3.3.7 Menu Settings

The “Menu Settings” page gives the user control over which menu items appear on the locator and the menu item's initial setting when the locator is first used after configuration.

The menu items with a right-pointing arrow  can be expanded to reveal additional sub-menu items. If the “On-Menu” item is ticked, then the item will appear on the locator menu. The item displayed in the “Setting” column will be the initial locator setting after configuration. If the “Setting” value is not selected, then the locator setting will be unchanged.

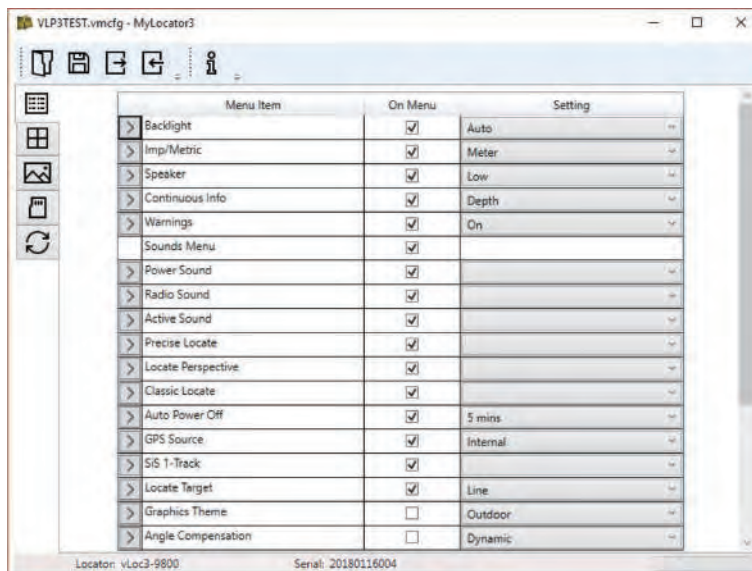

Menu Item	On Menu	Setting
> Backlight	<input checked="" type="checkbox"/>	Auto
> Imp/Metric	<input checked="" type="checkbox"/>	Meter
> Speaker	<input checked="" type="checkbox"/>	Low
> Continuous Info	<input checked="" type="checkbox"/>	Depth
> Warnings	<input checked="" type="checkbox"/>	On
Sounds Menu	<input checked="" type="checkbox"/>	
> Power Sound	<input checked="" type="checkbox"/>	
> Radio Sound	<input checked="" type="checkbox"/>	
> Active Sound	<input checked="" type="checkbox"/>	
> Precise Locate	<input checked="" type="checkbox"/>	
> Locate Perspective	<input checked="" type="checkbox"/>	
> Classic Locate	<input checked="" type="checkbox"/>	
> Auto Power Off	<input checked="" type="checkbox"/>	5 mins
> GPS Source	<input checked="" type="checkbox"/>	Internal
> SIS 1-Track	<input checked="" type="checkbox"/>	
> Locate Target	<input checked="" type="checkbox"/>	Line
> Graphics Theme	<input type="checkbox"/>	Outdoor
> Angle Compensation	<input type="checkbox"/>	Dynamic

Menu settings

3.3.8 Advanced Features

The Advanced Features are available to those users in possession of a USB security dongle. If a dongle is attached to the PC, its level will be displayed on the MyLocator3 status bar.

Three levels of security come with the dongle. Level one is for the end-user supervisors, level two for Vivax-Metrotech's distributors, repair centers, managers, and level three for Vivax-Metrotech use only.

3.3.8.1 Supervisor Lockouts

This feature is available to anyone with a dongle (contact Vivax-Metrotech to purchase a dongle). When a dongle is connected to your computer via a standard USB socket, the icons for the "Splash Screen" page, "Frequencies" page and the "Menu Settings" page will change color to green. This color indicates the page is unlocked.

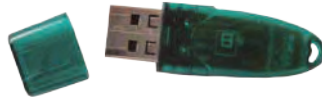

Levels of Dongle security

1. End-user supervisors
2. Vivax-Metrotech distributors, repair centers, and managers

The Splash Screen page, Frequencies page, and Menu Settings page can be individually locked by double-clicking on their page tab icon. If a page is locked, a user can only access it with an appropriate security dongle. Doing so will prevent unauthorized users from changing protected locator items. i.e., the "Splash Screen" can be locked to prevent the user from changing it.

The page tab icon will change color from green to amber.

To unlock a tab with the dongle connected, double-click on the tab to unlock.

4. Loc3 Series Transmitters

This section of the manual covers both the 5-watt and 10-watt Loc3 transmitters.

4.1 Loc3 Series Transmitter Overview

The Loc3 series transmitters are rugged portable transmitters powered by alkaline “D” cells or Li-ion rechargeable batteries. The following describes the features and uses of the transmitter.



- | | |
|----|---|
| 1. | Loc3 series transmitter |
| 2. | Ground stake |
| 3. | Direct connection lead |
| 4. | D cell alkaline batteries
5-watt = x 8, 10-watt = x 12 |
| 5. | Alkaline battery tray |
| 6. | Mini-USB lead |

4.1.1 The Transmitter Display

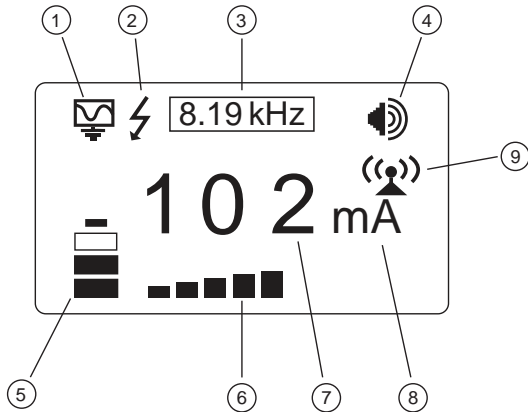

- | | |
|----|---|
| 1. | Mode indication icon |
| 2. | High Voltage Warning* |
| 3. | Active frequency |
| 4. | Speaker level |
| 5. | Battery status |
| 6. | Output step bar graph |
| 7. | Digital readout (mA, volts, ohms) |
| 8. | Units (mA, volts, ohms) |
| 9. | Tx-Link Status
Blinking icon = Tx-Link is not paired
Solid icon = Tx-Link is active and linked to the transmitter |

*Output Protect Warning

The transmitter checks the line when connected. Output protected against accidental momentary connection to up to 230V AC (RMS), it will display the high voltage warning icon and not allow the transmitter to operate. In addition, the transmitter is protected by a 4A/250V fuse in the event of excessive voltage or voltage spikes on the line.

4.1.2 Pushbuttons

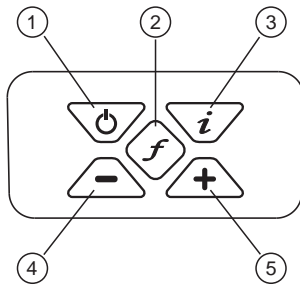

- | | |
|----|---|
| 1. | On/Off button |
| 2. | Frequency selector |
| 3. | Information (Volume, Volts, Ohms, Multi-frequencies LCD Contrast, Receiver Link, Frequency menu and About screen) |
| 4. | Output decrease/Navigate through the menu |
| 5. | Output increase/Navigate through the menu |

4.1.3 Transmitter Information Pushbutton

Press the “i” button to access the transmitter settings and menu.



Use the “+” and “-” buttons to navigate the settings and menus.



Use the “f” button to make selections. An X will appear for selected items.



5 and 10-Watt Transmitter Menu Structure

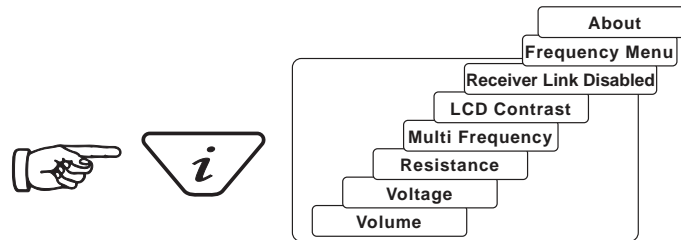

When the “i” pushbutton is pressed the display will show the volume level. Use the + and - pushbuttons to increase, reduce or turn the speaker off. (off-low-medium-high).

Keep pressing the “i” pushbutton, and the display can be toggled to show “voltage,” “resistance,” or other functions as shown in the illustration above. The display indicates mA as the default and volts or ohms when selected.



NOTE
The number of “i” button presses and available sub-menus will vary with the transmitter’s mode.

4.1.4 Connections Block

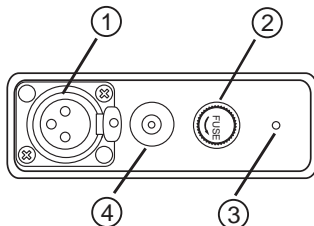

- | | |
|----|--|
| 1. | Output connection, 3-pin XLR |
| 2. | Fuse holder - Output protection (1.6A/250V Fuse) |
| 3. | Speaker |
| 4. | Battery charging & DC input socket |

All connections to the transmitter are made through the connection block.

4 Loc3 Series Transmitters

The connection block consists of:

- Output connection- 3-pin (XLR socket for direct connection lead and clamp.
- Fuse, 1.6A/250V – this protects the transmitter circuitry in the event of the transmitter receiving up to 250V incoming voltage on the output leads, or higher than the allowed current.
- Speaker - A beeper is positioned behind the small hole.
- Charger socket (charge rechargeable battery pack – the charging socket is present even if rechargeable batteries have not been purchased).
- Transmitter 12V DC power lead used to power the transmitter from a vehicle and if rechargeable batteries are fitted, will charge the transmitter at the same time.

4.2 Transmitter Batteries - Li-ion and Alkaline

5 and 10-Watt Transmitters - The 5-watt transmitter uses 8 x D cell alkaline batteries, while the 10-watt uses 12 x D cells.

On all transmitters the battery status is shown on the transmitter's LCD. The letters "LP" will appear when the battery status reaches only one bar. At this battery level, the max output current and power are limited.

The LED on the charger will show a red light indicating that the charge cycle is in progress. When the batteries are fully charged, the LED will change to green.

Follow the instructions detailed in the General Safety & Care Information section of this document. Dispose of batteries following your company's practice and environmental standards the prevailing laws or recognized best practices. Always dispose of batteries responsibly.



WARNING

Use only Vivax-Metrotech recommended charger.

Do not attempt to replace the rechargeable batteries or remove battery covers.

Return to Vivax-Metrotech or a Vivax-Metrotech approved service center for replacement.

4.3 Charging the Transmitter Battery Tray

The rechargeable battery tray can be charged while attached to the transmitter or on its own. The battery condition (status) is displayed on the transmitter's display.

1. Connect the charger to the charging socket on the transmitter's side or directly into the battery tray's charging socket.
2. The LED on the charger will glow red while charging and turn green when fully charged.

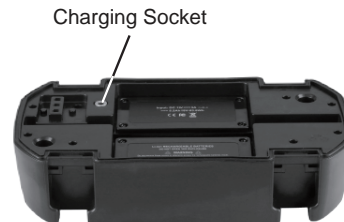
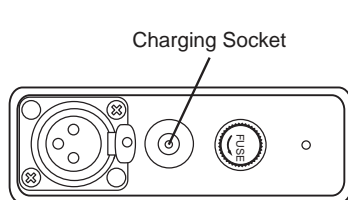

Plug the charger into the charging socket on the side of the transmitter or directly into the battery tray

Battery Charger - is supplied with the optional Li-ion battery tray.



Optional 12-volt DC Power Lead - this 30ft/90m lead can be used to power the transmitter when connected to a target line at high output levels for extended periods. It will not charge the transmitter battery.





WARNING

Only use a charger supplied by Vivax-Metrotech Corp. Using non-approved chargers may damage the equipment or overheating/explosion.





The rechargeable tray cannot be charged from a 12V DC source.

Follow instructions detailed in the General Safety & Care Information section of this manual. Only use the battery charger supplied as using an unapproved charger may damage the battery pack and cause overheating.

4.4 Removing and Installing the Battery Tray

These procedures apply to both the Alkaline and Rechargeable battery tray.

Removing the battery tray		
		
1. Reach under the catch and pull to unlock.	2. Lift the catch and repeat for all four catches.	3. Lift the transmitter base from the battery tray.

Installing the battery tray		
		
<p>The battery tray and transmitter base have a matching aligning post, contact pins and socket.</p> <p>Aligning the contact pins in their receptacles will ensure that they will mate and not get damaged.</p>	1. Align the aligning post and lower the transmitter base into the battery tray.	2. Press down on the locking catch until it clicks and locks in place. Rotate the transmitter locking all the latches.

4.5 Transmitting Modes



WARNING

Always connect the transmitter to the target line following your company's procedures. These operations should only be performed by authorized personnel. Always make connections before switching on the unit. Turn the transmitter off before disconnecting.

4.5.1 Direct Connection Mode

The **Direct Connection** mode is automatically selected by plugging a connection lead into the output socket. An icon confirming the direct connection mode is shown on the display. The wave in the icon fluctuates when the transmitter is operating. The direct connection lead consists of two colored cables with clips and covers. The red clip must be connected to the conductor being located, the black clip to a suitable ground such as the ground stake provided with the transmitter.

A good connection is indicated by a change in the beep rate from the speaker and the current reading on the display.

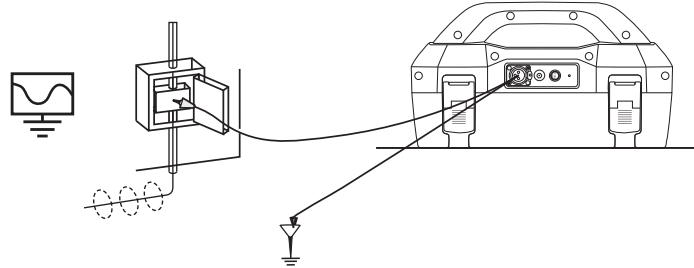

Wherever a direct connection can be safely made without the risk of injury, damage to the customer's plant, or the transmitter, it is the best way of applying the transmitter's signal.

The positioning of the ground connection can also influence the degree of coupling experienced. Ground connections should not be made to other pipes or cables or above ground metallic structures such as wire fences. In general, the lower the frequency is, the further the signal will travel, and the less signal-coupling will occur. The most common frequencies used for direct connection are between 512Hz/640Hz and 8kHz.

Regulations in many countries require that power output is limited above specific frequencies. The Loc3 series 5-watt, 10-watt, and 25-watt transmitters enable frequencies below 45kHz to be transmitted using as much as 5-watts, 10-watts or 25-watt output, depending on your transmitter, but frequencies over 45kHz are restricted to 1-watt. Using direct connection and the higher power at the low frequencies helps significantly in achieving greater location distances. Direct connections should not be made to cables carrying greater than 25V (or as your safety practices allow). The transmitter is protected (250V fuse) from stray currents that may exist on the target line.

4.5.2 Clamp Mode

The transmitter signal clamp is a precise way to apply the locate signal. Clamps are generally used when it is impossible to access the conductor to make a direct connection, but there is access to place the clamp around the cable. Clamps are also used when it is not safe to connect because the target cable is live carrying electricity.

The clamp is a specialized inductive device (sometimes known as a toroid or coupler). All clamps are optimized to work at specific frequencies. In most cases, clamps are designed to be used at frequencies generally between 8kHz and 9.82kHz. The transmitter will only allow the selection of a suitable range of frequencies for your clamp.

Plugging a Vivax-Metrotech clamp into the output socket will place the transmitter into the "Clamp" mode. An icon confirming this is shown on the display and will flash when the transmitter is transmitting.

When using the clamp, no ground connection is needed.

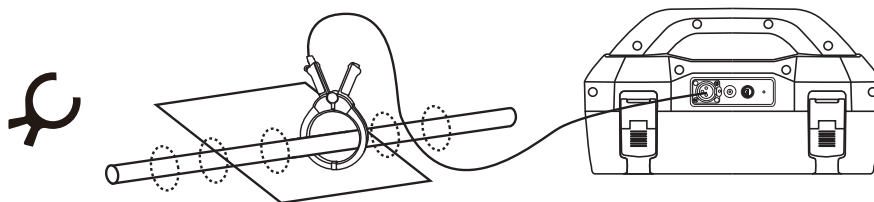

WARNING

When applying the clamp to cables that carry electricity – be sure to follow your company's safety instructions and procedures. Beware that if applied around a high voltage cable – that cable may induce a current in the clamp, causing it to snap shut or jump quite dramatically – always apply clamps carefully.

4.5.3 Induction Mode – 5 and 10-Watt Transmitters Only

The 5 and 10-watt transmitters use an internal antenna to induce a locating frequency onto the target utility. The Induction mode is automatically selected if no connection accessories are plugged into the “output socket.” An icon indicating the “Induction” mode will show on the display. The icon flashes when the transmitter is transmitting. The transmitter should be positioned over and with the handle in line with the target to generate successful induction.

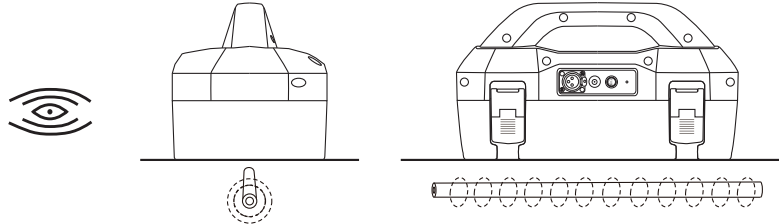

“Induction” mode is generally used when no access is available to make a direct or clamp connection. When using induction, likely, the signal being induced onto the target line will also be induced onto other lines in the area and onto above-ground features such as wire fences. This can influence the accuracy of the location, depth, and current measurements. “Induction” mode is also the least efficient way of applying the transmitting signal to the target line. The distance located with the “Induction” mode is generally much less than that achieved with a direct or clamp connection. The “Induction” mode is only available from 8kHz and above.

Induction frequencies are available based on user selection. See section 4.6.2 for information relating to the “Most Used Frequencies (Frequency Selection) Feature” to add and remove frequencies from the favorite frequencies list.



NOTE
For accurate location and depth measurement, the locator receiver should be used no closer than 66ft (20m) from the transmitter.

4.6 Transmitter Frequencies

The Loc3 series transmitters are supplied with a predefined set of transmitting frequencies. The factory will preset the most commonly used frequencies. Additional frequencies are available to be selected in the frequencies list.

4.6.1 Frequencies and Maximum Power Output

5 and 10-Watt Transmitters

Frequencies power outputs	Loc3-5Tx	Loc3-10Tx
Direct connection 10-watt:	-	98Hz-45kHz
Direct connection 5-watt:	98Hz-45kHz	-
Direct connection 1-watt:	>45kHz-200kHz	>45kHz-200kHz

Clamp Connection: Available frequencies between 8.19 kHz and 200 kHz

Induction Frequency: Multiple induction frequencies between 8.19kHz and 200kHz

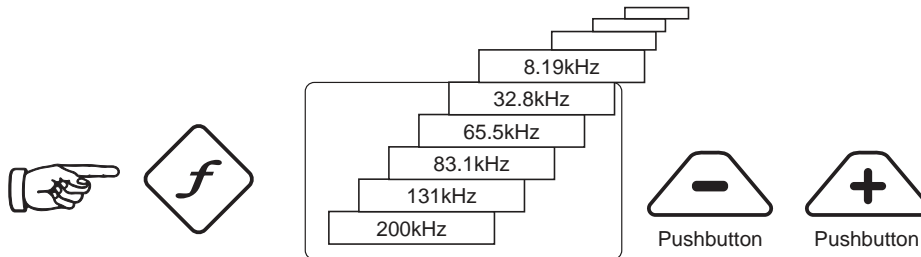

As with most manufacturers, signal clamps are tuned to specific frequencies and **will not** work over the complete range of frequencies.

Frequencies are selected by pressing the “f” pushbutton, which toggles through the frequencies available in the current mode's available frequencies. The frequency is automatically selected if you don't toggle past it within two seconds.

NOTE



The output current is shown in large characters on the display. To increase or reduce the current output, press “+” or “-.” The vertical bar graph at the bottom of the display indicates which of the seven current output steps is used. If the transmitter can supply the requested current, the bar will turn black. If the bar does not turn black, improving the ground connections or wetting the ground where the earth stake is positioned may help. However, it may not achieve the current setting requested because the line's impedance is too high for this setting. It is best to select a lower setting with a black bar, ensuring a stable output if this happens.

The impedance of the target line will limit the current being transmitted; therefore, it is not unusual to increase the output level but see no increase in the currently displayed. This is not a fault with the transmitter.

The transmitter will always revert to first-level output when switched on as a power-saving feature. In most circumstances, this output level is sufficient. Increasing the output power unnecessarily will reduce battery life. All other settings remain the same as the last setting used.

4.6.2 Most Used Frequencies (Frequency Selection) Feature

This feature allows the operator to choose the most used frequencies from a list of frequencies. Once these frequencies are selected in the main menu, the user can scroll through them by pressing the “f” push button. The user can add or remove frequencies from the above list by following the below procedure. The maximum number of frequencies that can be activated in the most used frequencies list is 12.

The advantage of this feature is the user can work with only their preferred frequencies rather than having a more extensive list of frequencies to scroll through.

Enter the Frequency Menu:

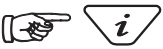
1.  Press the “i” pushbutton four to six times (based on the mode that the transmitter is in) until reaching the “Frequency menu” sub-menu.

In Direct Connection mode

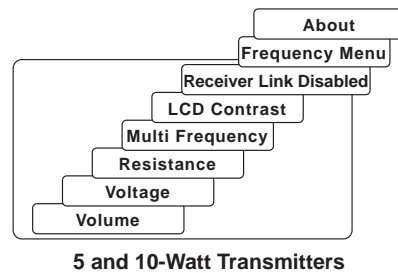

In SD Mode

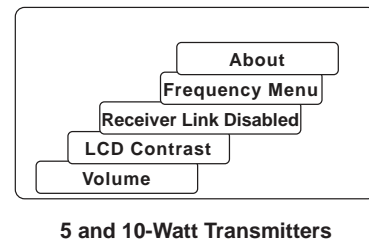

In Clamp Mode

2. The screen will show a list of frequencies available, with the central one in a box.

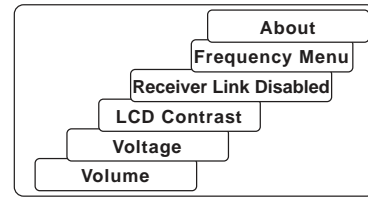

5 and 10-Watt Transmitters

3. You can scroll up or down through the available frequencies by pressing the “+” or “-” pushbuttons.

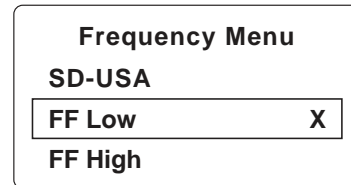

5 and 10-Watt Transmitters

4. Once the wanted frequency is inside the box, press the “f” pushbutton to select or deselect the frequency. An “x” will appear in the box for a selected frequency.

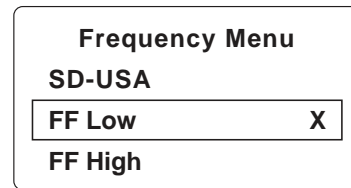

5 and 10-Watt Transmitters

5. After selecting the frequencies, press the “i” pushbutton again to exit the “Frequency Menu” and return to the main display.
 6. A frequency in the chosen list of frequencies can be selected from the screen by pressing the “f” pushbutton until the wanted frequency is displayed at the top of the main screen.

4.6.3 Multi-Frequency Mode for Direct Connection

This feature can be used to energize two or three frequencies simultaneously on the target line. This is especially helpful when the user is unsure which frequency is best to apply to the target line.



NOTE

- When using the multi-frequency mode, total power will be split between the activated frequencies.
- The multi-frequency mode is not available in Fault Find and SD modes.
- The frequencies have to be available in the main menu.

Enter the Multi-frequency Setup menu:

1. Press the “i” pushbutton seven times to get to the “Multi-Frequency” screen and press the “f” pushbutton to activate the multi-frequency mode. An “x” symbol will appear, indicating that the multi-frequency mode is activated. Press the “f” pushbutton again to go to the “Multi-Frequency. Setup” screen to choose the frequencies.

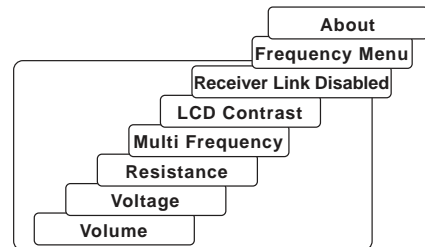

4 Loc3 Series Transmitters

2. Use the "+" and "-" pushbuttons to scroll through the available frequencies and add the desired frequency in the first box.

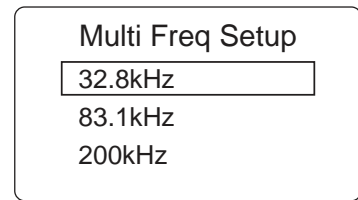

3. Press the "f" pushbutton to move the box down and the "+" and "-" pushbuttons to select the second frequency.

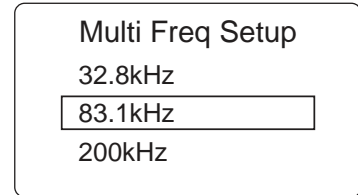

4. Repeat step three to select the third frequency if needed.

5. Press the "i" pushbutton to return to the main display. On the main display, "Multi" will appear, indicating the multi-frequency mode is active.

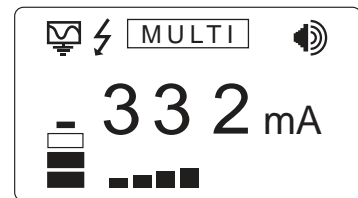

6. The frequencies selected for multi-frequency mode will be saved until changes are made, even when the multi-frequency mode is deactivated.

4.7 Transmitter Link (TX-Link)

Currently, the Tx-Link feature is **only available in the 5-watt and 10-watt transmitters.**

The Loc3 series transmitters can be remotely operated from the vLoc3 receiver. This option requires the Transmitter (radio) Link to be installed in both the vLoc3 series receiver and the Loc3 series transmitter.

Tx-Link is a factory fit option that must be purchased at the time of ordering. The radio link range depends on having a clear "line of sight" between Rx and Tx but is typically around 300m (984ft).

The Tx-Link feature is shown as RECEIVER LINK in the menu.

Linking a transmitter to a receiver:

1. Press the "f" button repeatedly to scroll through the options until the "RECEIVER LINK DISABLED" option is displayed.



2. Press the "+" key to enter the Receiver Link menu. Press the "+" or "-" key to highlight the "ENABLE" option, then press the "F" key to start the process. The display will show the message "WAIT" until the setup is complete.

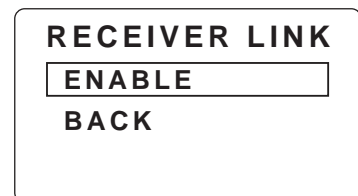

4 Loc3 Series Transmitters

- An ID number will now be displayed at the bottom of the screen for identification purposes.
- The transmitter is now waiting to connect to a receiver. Either press the "I" button or use the "+" and "-" keys to highlight "BACK" then the "F" key to exit back to the main screen.

When on the main screen, a "beacon" icon will be displayed on the right-hand side. When the icon is flashing, the transmitter is waiting to connect to a receiver. The flashing will stop when successfully connected to the receiver. If no icon is visible, this indicates that the Receiver Radio Link has not been activated.

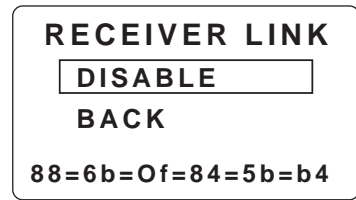

- While the icon on the transmitter is flashing, indicating that it is waiting to connect to a receiver, switch on the vLoc3 series receiver and enter the user menu by pressing and holding the information button. Scroll down the menu options until Transmitter Link is highlighted. Note that the transmitter and receiver sides of the radio links can be switched on in any order.

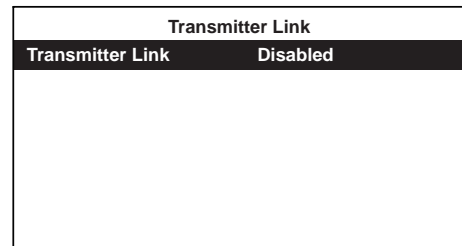
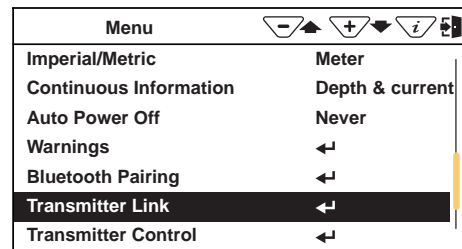

- Select the "Transmitter Link." Check that the radio module is enabled. If not, press the return button to enable the Transmitter Link. After a short scan, the available devices will be displayed. Highlight the one to be selected and press the return button. Press the information button to return to the main menu.

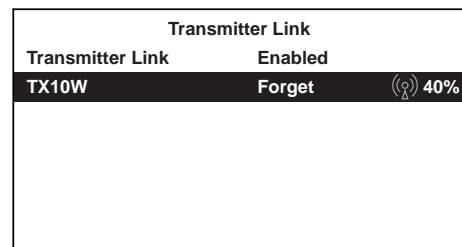

- The "Beacon" icon on the transmitter should not be flashing anymore at this point. A solid icon indicates that the link has been established.

- From the main menu, select the "Transmitter Control" option. (that will become visible when the two devices are linked) A screen similar to the below should be seen:

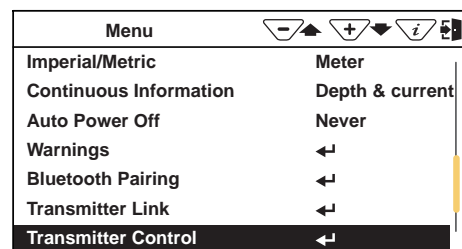

From this screen, if the link status shows “Connected,” it is possible to:

- Alter the output level of the transmitter using the “+” and “-” buttons.
- Alter the transmit frequency using the “f” button.

Also shown is the following:

- Radio link signal strength, in this case, 40%.
- Output mode, in this case, direct connection.
- Output current, in this case, 100mA.
- Beeper volume setting, in this case, level 2.
- Transmitter battery level.

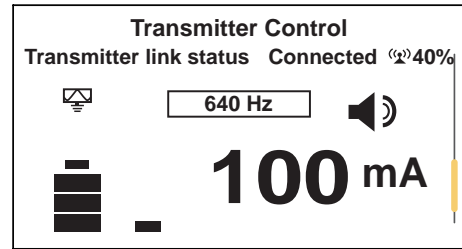



Use the Information button to navigate/exit back to the locate screen.
 When in the Locate screen, the status of the Link is displayed in the Status bar.





The various indications of the status are listed below:

-  No radio module or it is disabled (Always disable in the User Menu when not in use)

-  No link and no signal

-  No link and poor signal

-  No link but good signal

-  Is linked to the transmitter, but the signal is poor

-  Is linked to the transmitter with a good signal



TIP

While the Transmitter and Receiver are linked, changing the Receiver Frequency will automatically result in a similar change to the Transmitter frequency, so there is no need to re-enter the menu screen to change the Transmitter frequency remotely. The Frequency indicator will flash when resetting or if an invalid frequency is requested.

The radio link will continue to search for the transmitter or receiver that may interfere with the Bluetooth operation. If the Tx/Rx Radio link is not used, ensure the receiver’s link is set to “Disabled” on the RX and TX. Also, disabling when not in use will conserve battery charge.

5. Accessories & Options

5.1 Transmitter Signal Clamps



Clamps are accessories used to apply the transmitter signal to an insulated line, removing the need to connect the transmitter signal directly to a conductor or cable sheath. Clamps are available in 2-inch (50mm), 4-inch (100mm) and 5-inch sizes. An 18-inch (45cm) flexible version is also available.

5.2 A-frame Fault Locator



The A-frame accessory is used to detect ground faults on pipes and cables. In the case of pipes, the faults consist of coating defects. In cables, faults are usually caused by insulation damage allowing the metallic sheath (or internal conductor) to contact the earth.

5.3 vLoc3-MLA (Marker Locator Adapter)





The vLoc3-MLA (Marker Locator Adapter) is designed for easy, fast, and accurate location of buried EMS markers. Once located, the MLA will give the depth of cover to the buried marker with the touch of a button.

The MLA attaches to the bottom of vLoc3-Pro, vLoc3-9800, and vLoc3-5000 receivers. When attached and plugged into the receivers, two marker related operating modes are enabled.

Visit us at www.vxmt.com to see the full range of receiver and transmitter accessories and available options.

6. Glossary

Active Locate	A locate where a transmitter is used to apply a signal to a buried pipe or cable, the position of which is then located by a receiver tuned to the same frequency.
Active Signal	A signal applied by the locator transmitter to a buried line. Typical this is a very precise frequency.
Attenuation	The reduction of an electromagnetic signal from a pipe or cable.
Clamp (or Coupler)	An accessory used to apply the transmitter signal to an insulated line, removing the need to connect the transmitter signal directly to a conductor or cable sheath.
Compass	Line direction indicator (although visually like a compass, is the only relation to a compass.)
Coupling	The act of signals transferring to lines to which they were not originally applied. The coupling can be "direct" where the target line has an electrical connection to another line or "induced" where the signal radiates from the target line to another line or lines.
Display	The information visually available on the dot matrix display.
Line	A generic term for any buried pipe or cable.
Null	A minimum response to a buried line. 
Passive Locate	The Receiver searches for a wide range of signals that radiate from buried pipes or cables. These signals come from various sources in the environment and couple to the buried (& overhead) lines. Typical examples are 50 / 60Hz and LF/VLF radio.
Passive signals	A wide range of signals that radiate from buried pipes or cables. These signals come from various sources in the environment and couple to the buried (& overhead) lines. Typical examples are 50/60Hz and LF/VLF radio.
Peak	A maximum response to a buried line. 
Pinpoint	Using a receiver to identify the exact position of a buried line.
Response	The indication that the receiver gives is caused by the signals it is receiving. This can be visual, audio or both. Typically, it is displayed on the locator's dot matrix display and audibly from a loudspeaker in the receiver housing.
Search (sweep)	This describes the act of looking for a buried line within a given area.
Sonde	A small transmitting coil that may be built into a product such as a sewer camera or packaged as a small self-contained battery-powered transmitter. A receiver tuned to the same frequency can locate the position of the Sonde and hence whatever it is attached to or in. Sondes are frequently used for locating sewer cameras and tracing non-metallic pipes and ducts.
Target Line	The buried pipe or cable to be located.
Trace	Using a locator to follow the path of a buried line.

Illustrations used in this manual's preparation will inevitably show some resemblance to similar illustrations from other manufacturers. These manufacturers have permitted the use of their graphics. This statement is intended to attribute such credit.

The Bluetooth® word mark and logos are registered trademarks owned by the Bluetooth SIG, Inc.
 iOS is a trademark of Cisco Systems, Inc., registered in the U.S.
 Android, Google and Google Maps are registered trademarks of Google LLC.

Disclaimer: Product and accessory specification and availability information are subject to change without prior notice.

